

# Car Beauty Light Catalog ▶▶

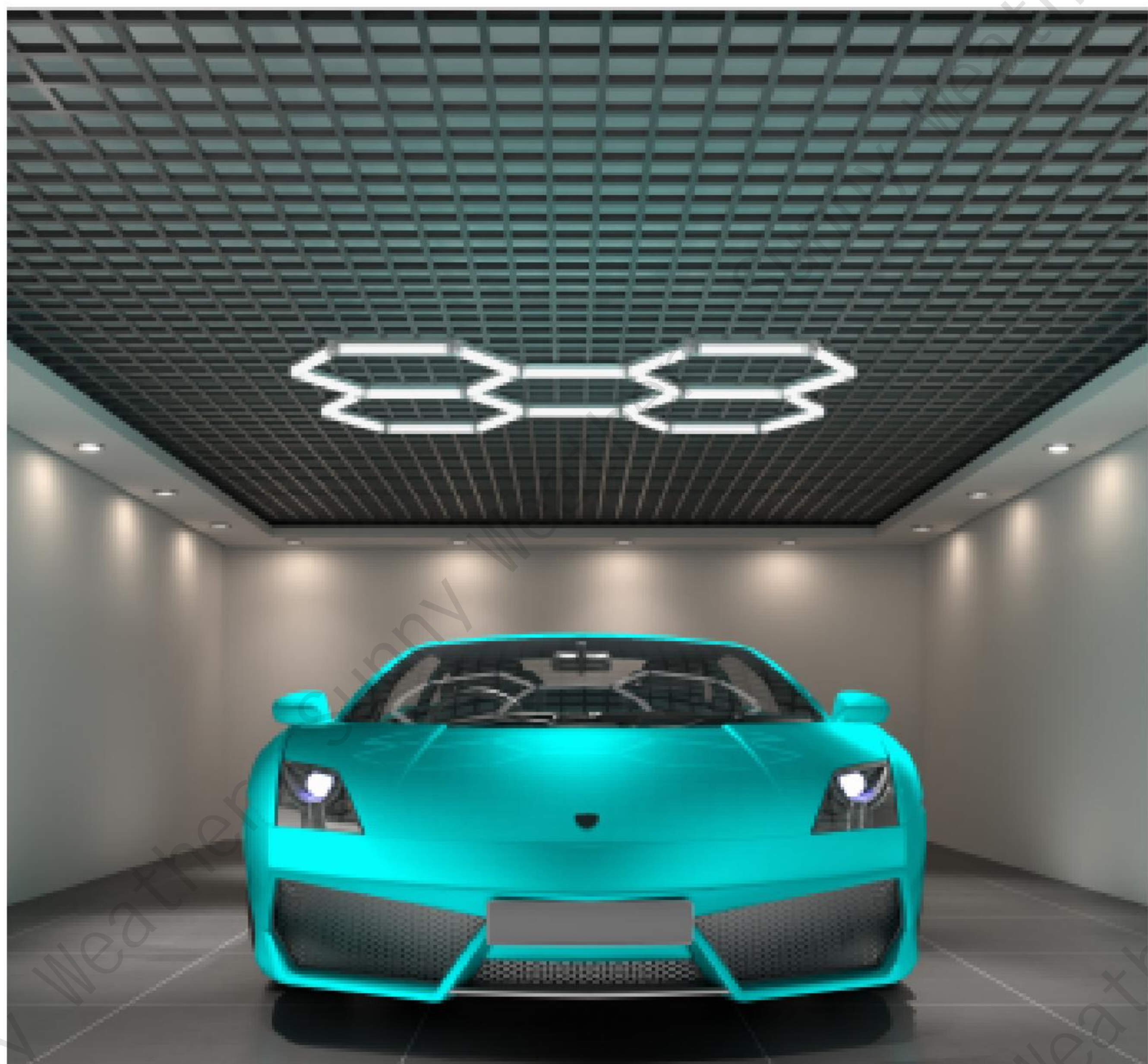

## Garage Hexagon Lighting

Car Care Workshop Lights,  
Car Wash Workshop Lights, Car Wash Workshop Lights



型号 Model	<b>BBH011</b>	通光量 Light transmission	100-120LM/W
电压 voltage	220V-110V	显色指数 Color rendering index	>90
发光面 Luminous surface	22mm	色温 Temperature	正白 (6500K) white
功率 power	<b>168W/192W</b>	全套数量 Full set quantity	内框 Inside frame
尺寸 size	<b>2309x1604mm</b> 2928x2037mm		

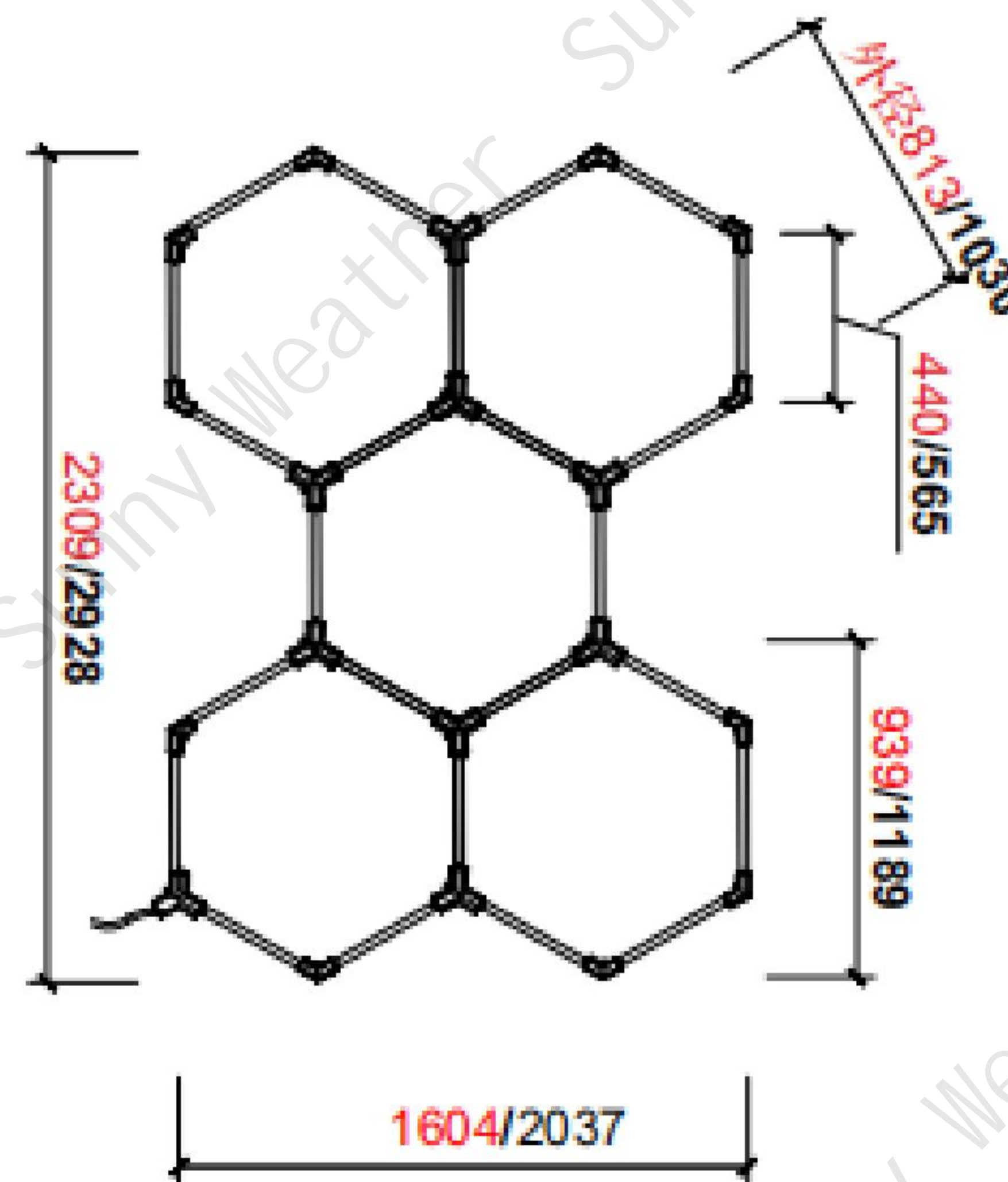

备注：红色字体代表是440灯管  
黑色字体代表是565灯管

Note: The red font represents the 440 lamp tube  
The black font represents the 565 lamp tube

编号 NO	配件明细 Parts	数量 quantity
<b>A</b>	<b>440mm灯管/Lamp tube</b>	<b>24</b>
<b>B</b>	<b>565mm灯管/Lamp tube</b>	<b>24</b>

编号 NO	配件明细 Parts	数量 quantity
<b>F</b>	V型/V-shaped	<b>11</b>
<b>G</b>	Y型/Y-shaped	<b>9</b>
<b>H</b>	电源线/Power cord	<b>1</b>

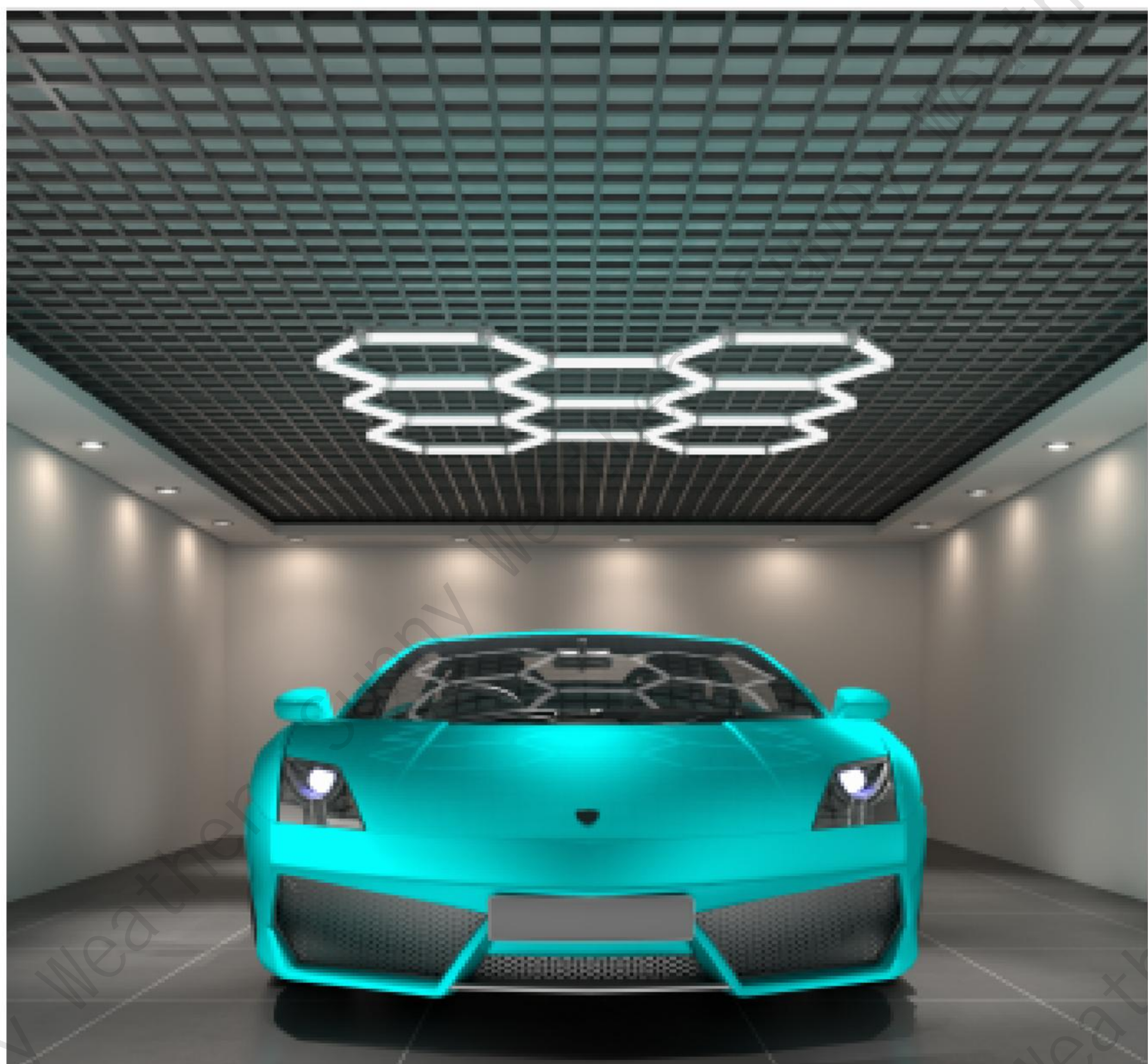

型号 Model	<b>BBH012</b>	通光量 Light transmission	100-120LM/W
电压 voltage	220V-110V	显色指数 Color rendering index	>90
发光面 Luminous surface	22mm	色温 Temperature	正白 (6500K) white
功率 power	<b>245W/280W</b>	全套数量 Full set quantity	内框 Inside frame
尺寸 size	<b>2309x2395mm</b> 2928x3045mm		

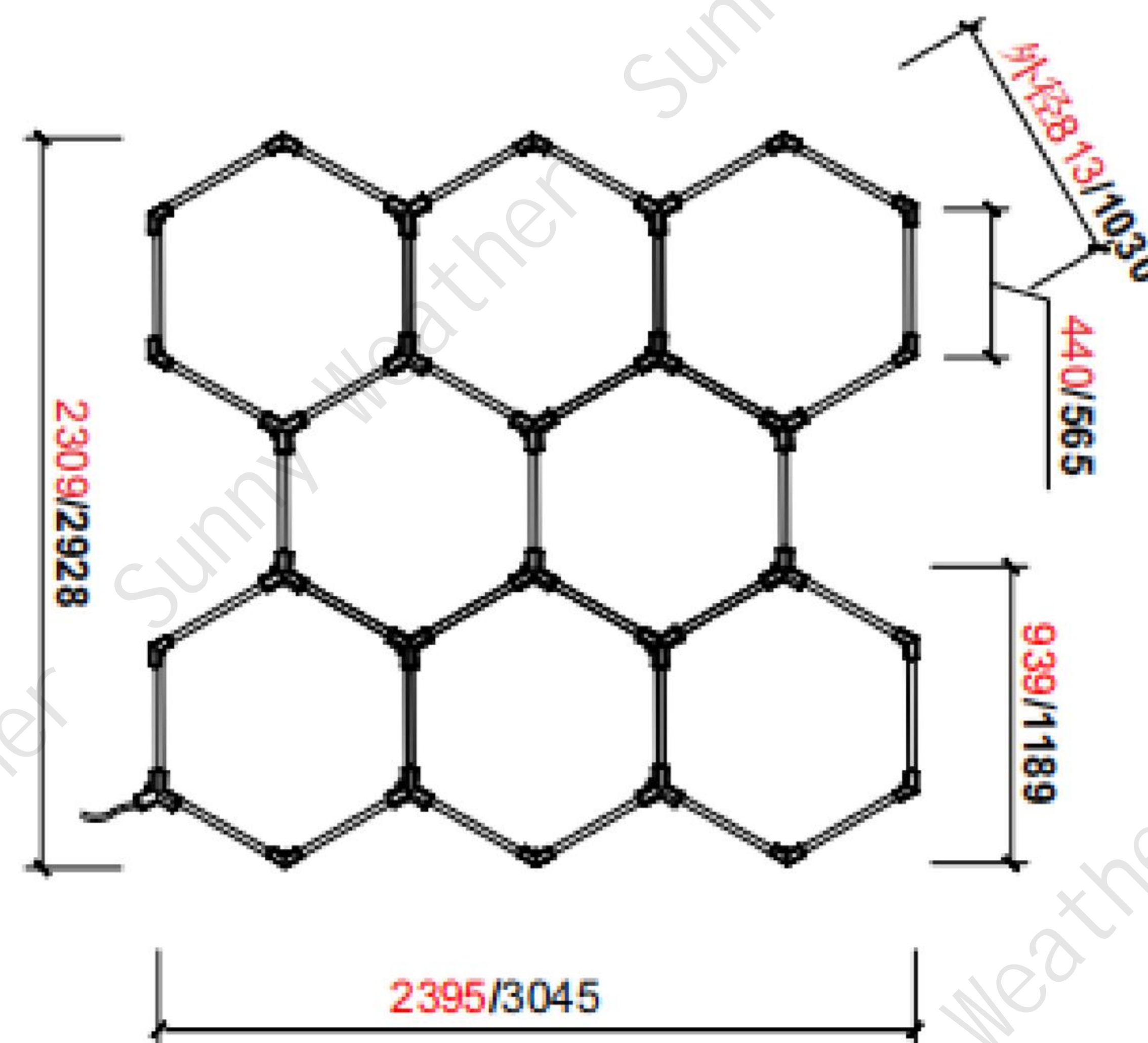

备注：红色字体代表是440灯管  
黑色字体代表是565灯管

Note: The red font represents the 440 lamp tube  
The black font represents the 565 lamp tube

编号 NO	配件明细 Parts	数量 quantity
<b>A</b>	<b>440mm灯管/Lamp tube</b>	<b>35</b>
<b>B</b>	<b>565mm灯管/Lamp tube</b>	<b>35</b>

编号 NO	配件明细 Parts	数量 quantity
<b>F</b>	V型/V-shaped	13
<b>G</b>	Y型/Y-shaped	15
<b>H</b>	电源线/Power cord	1

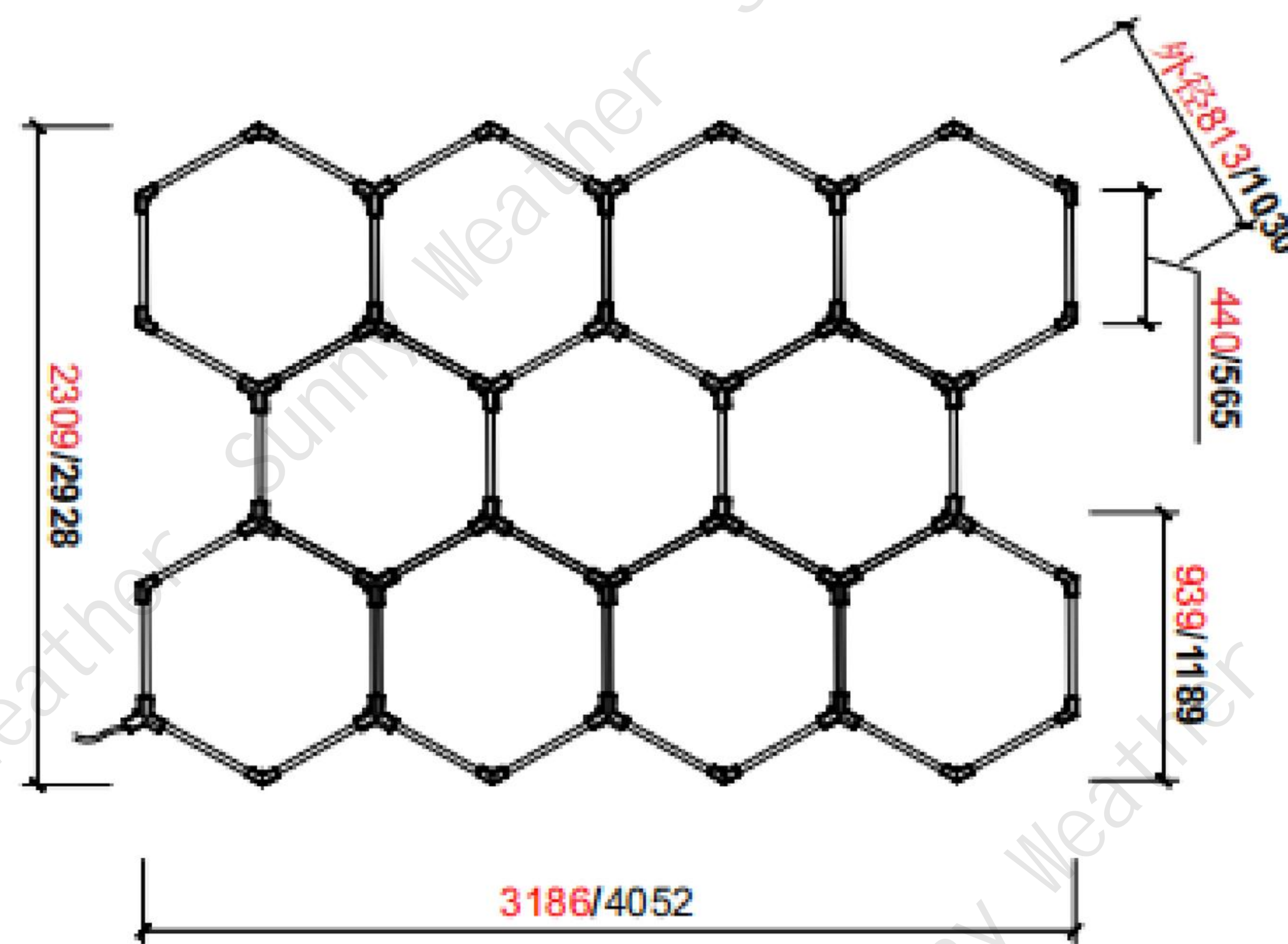
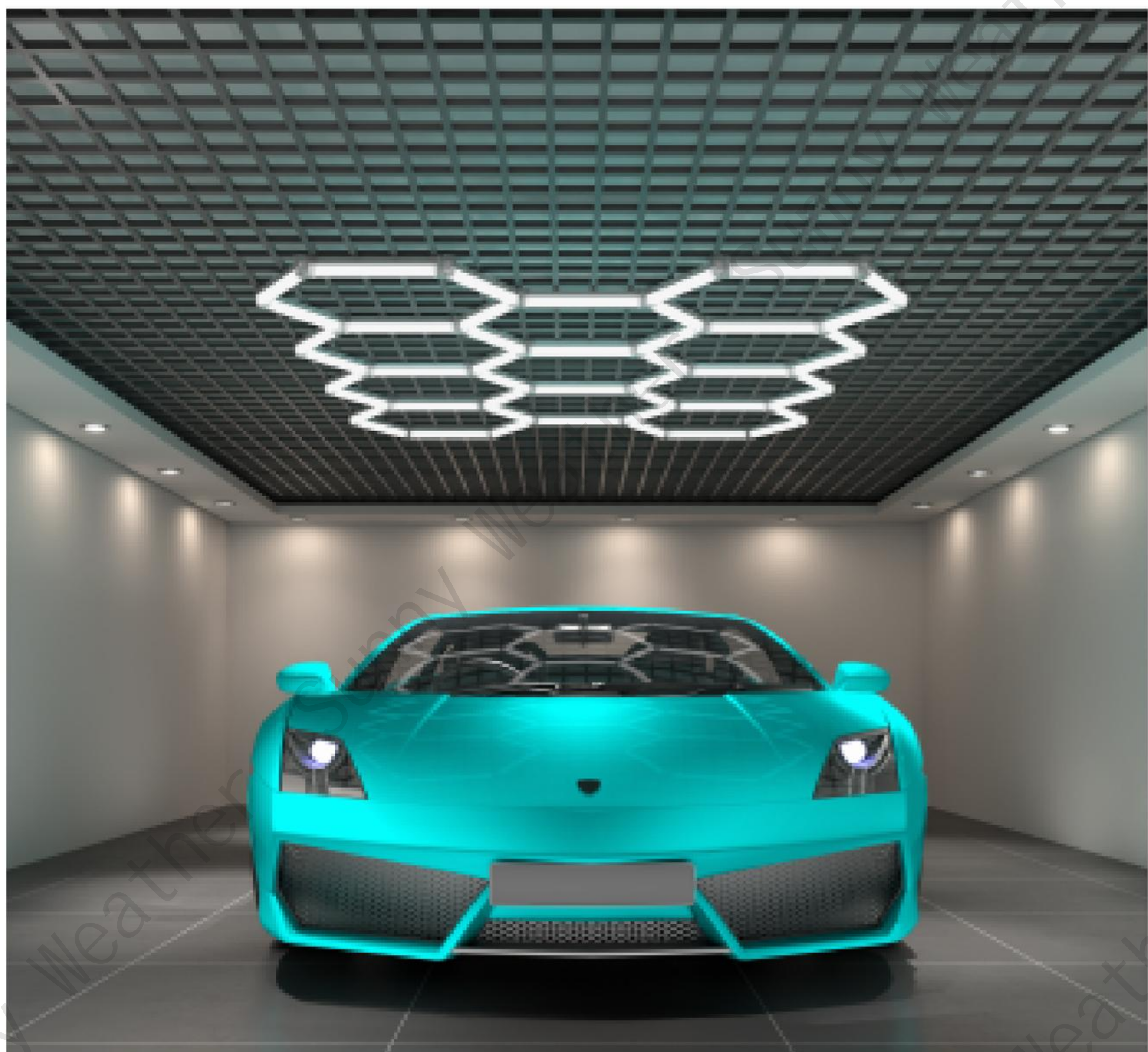

备注：红色字体代表是440灯管  
黑色字体代表是565灯管

Note: The red font represents the 440 lamp tube  
The black font represents the 565 lamp tube

型号 Model	BBH013	通光量 Light transmission	100-120LM/W
电压 voltage	220V-110V	显色指数 Color rendering index	>90
发光面 Luminous surface	22mm	色温 Temperature	正白 (6500K) white
功率 power	322W/368W	全套数量 Full set quantity	内框 Inside frame
尺寸 size	2309x3186mm 2928x4052mm		

编号 NO	配件明细 Parts	数量 quantity
A	440mm灯管/Lamp tube	46
B	565mm灯管/Lamp tube	46

编号 NO	配件明细 Parts	数量 quantity
F	V型/V-shaped	15
G	Y型/Y-shaped	21
H	电源线/Power cord	1

# LIGHTING SERIES

BBH014

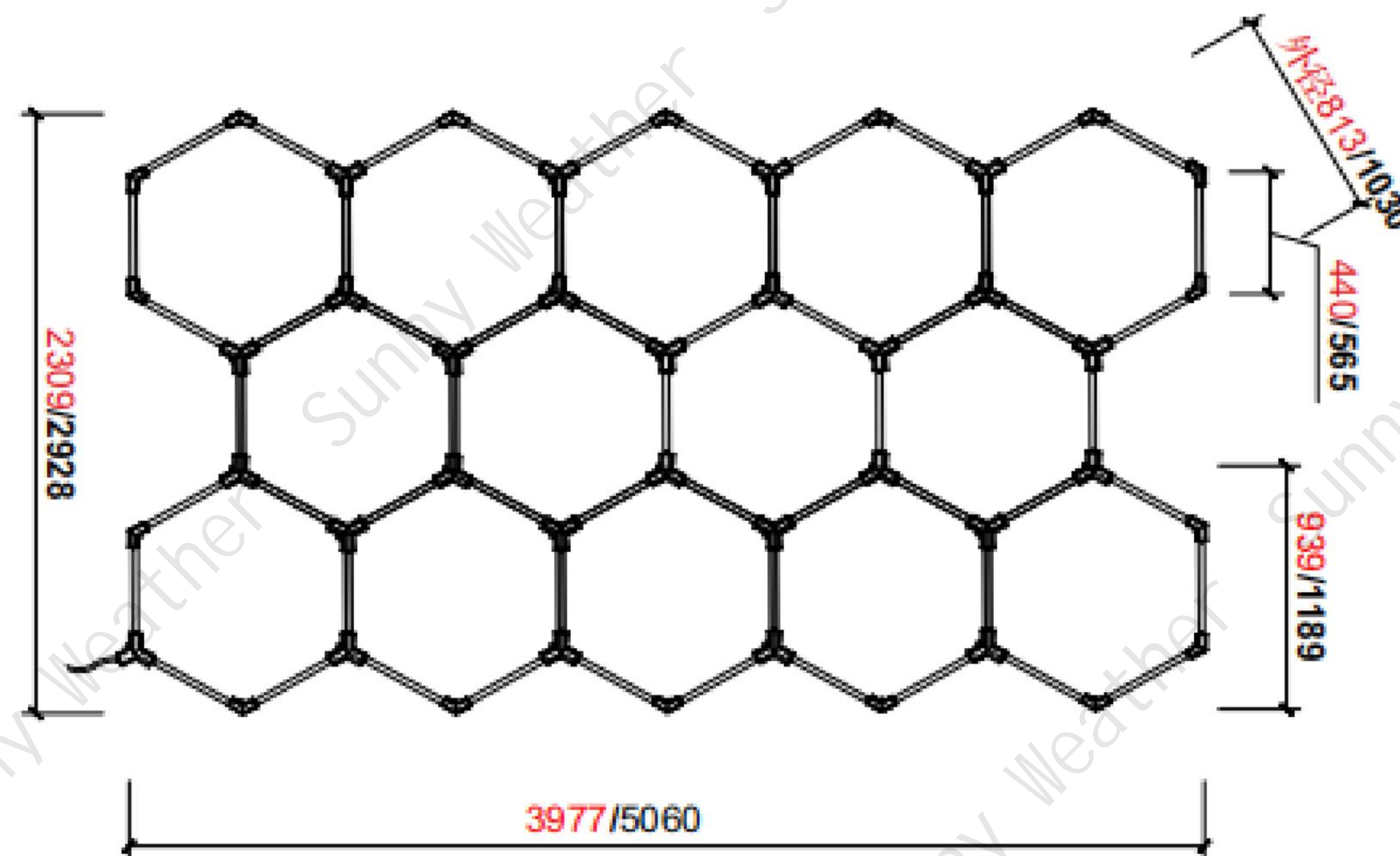
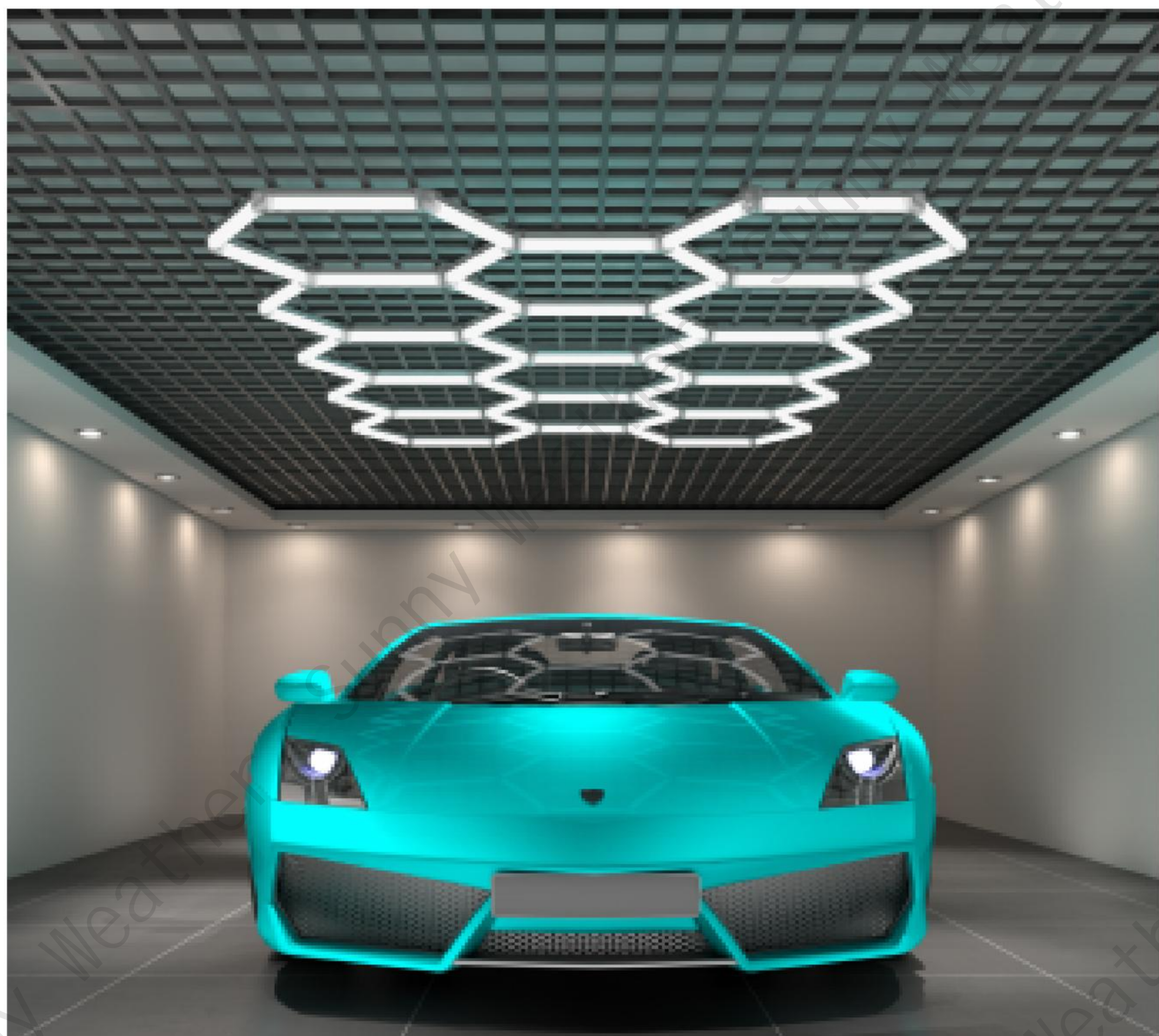

备注：红色字体代表是440灯管  
黑色字体代表是565灯管

Note: The red font represents the 440 lamp tube  
The black font represents the 565 lamp tube

型号 Model	BBH014	通光量 Light transmission	100-120LM/W
电压 voltage	220V-110V	显色指数 Color rendering index	>90
发光面 Luminous surface	22mm	色温 Temperature	正白 (6500K) white
功率 power	399W/456W	全套数量 Full set quantity	内框 Inside frame
尺寸 size	2309x3977mm 2928x5060mm		

编号 NO	配件明细 Parts	数量 quantity
A	440mm灯管/Lamp tube	57
B	565mm灯管/Lamp tube	57

编号 NO	配件明细 Parts	数量 quantity
F	V型/V-shaped	17
G	Y型/Y-shaped	27
H	电源线/Power cord	1

# LIGHTING SERIES

BBH015

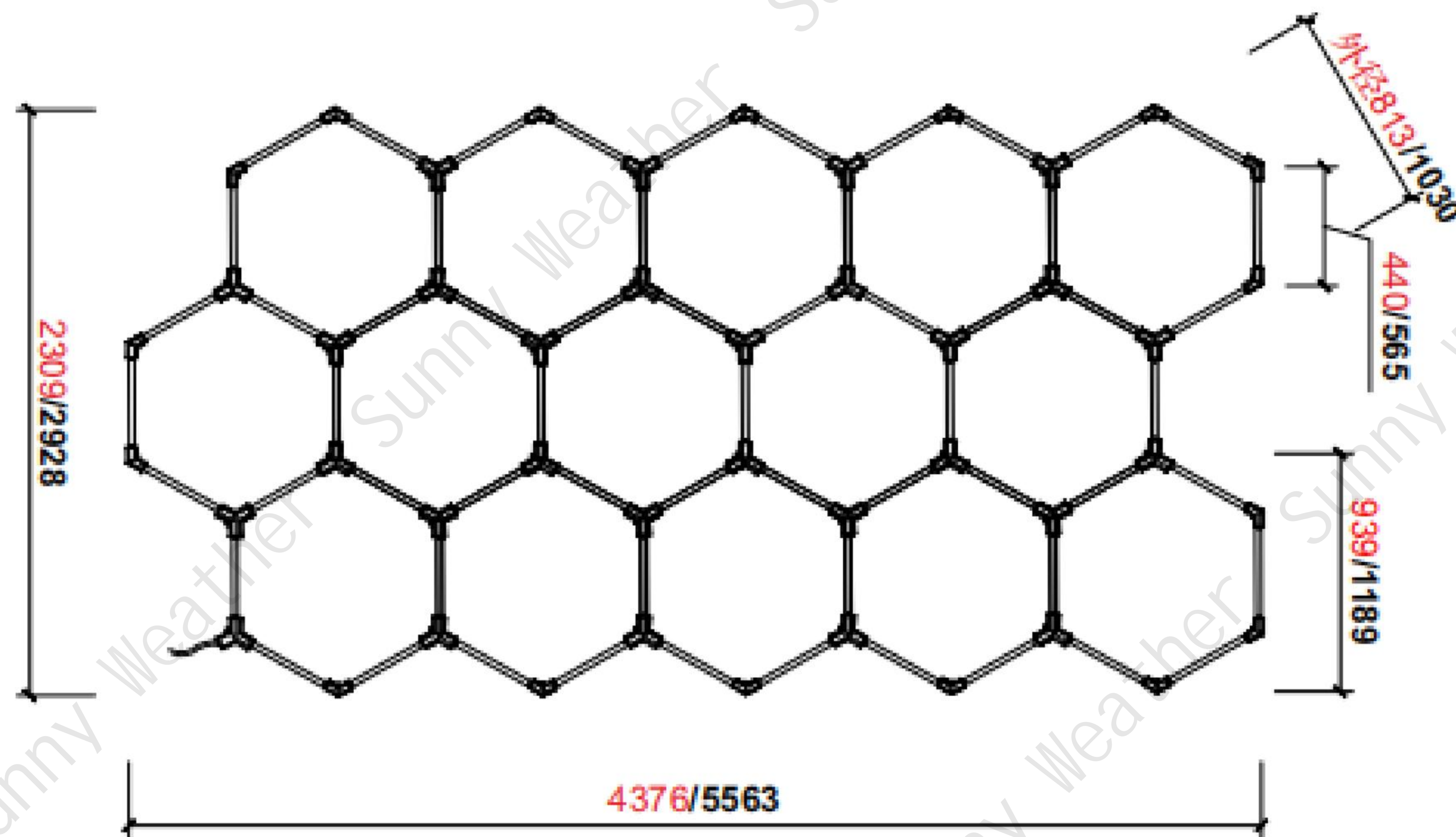
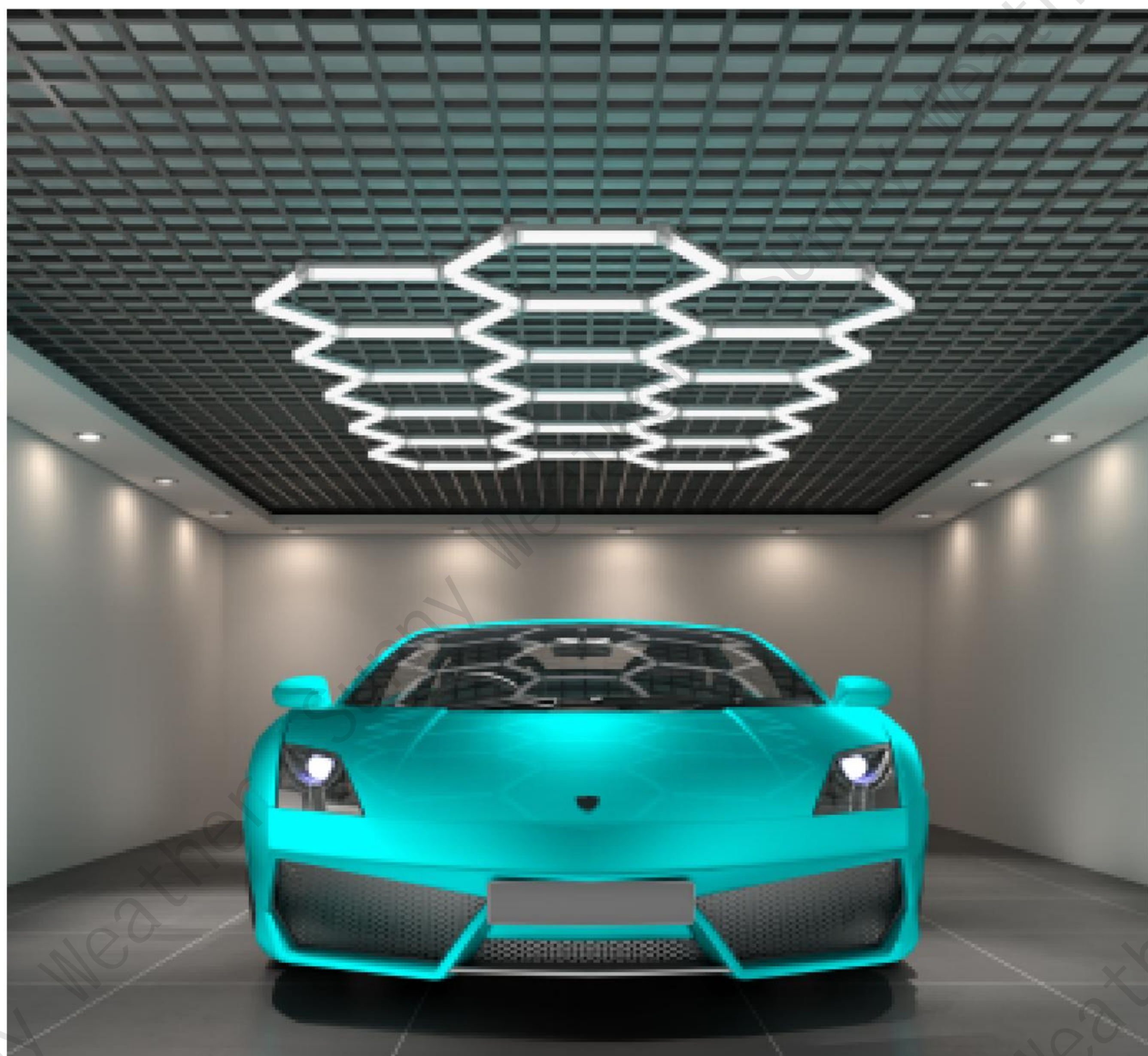

备注：红色字体代表是440灯管  
黑色字体代表是565灯管

Note: The red font represents the 440 lamp tube  
The black font represents the 565 lamp tube

型号 Model	BBH015	通光量 Light transmission	100-120LM/W
电压 voltage	220V-110V	显色指数 Color rendering index	>90
发光面 Luminous surface	22mm	色温 Temperature	正白 (6500K) white
功率 power	420W/480W	全套数量 Full set quantity	内框 Inside frame
尺寸 size	2309x4376mm 2928x5563mm		

编号 NO	配件明细 Parts	数量 quantity
A	440mm灯管/Lamp tube	60
B	565mm灯管/Lamp tube	60

编号 NO	配件明细 Parts	数量 quantity
F	V型/V-shaped	17
G	Y型/Y-shaped	29
H	电源线/Power cord	1

# LIGHTING SERIES

BBY011



型号 Model	BBY011	通光量 Light transmission	100-120LM/W
电压 voltage	220V-110V	显色指数 Color rendering index	>90
发光面 Luminous surface	22mm	色温 Temperature	正白 (6500K) white
功率 power	603W	全套数量 Full set quantity	外框+内框 Outer frame + inner frame
尺寸 size	2435x4835mm		

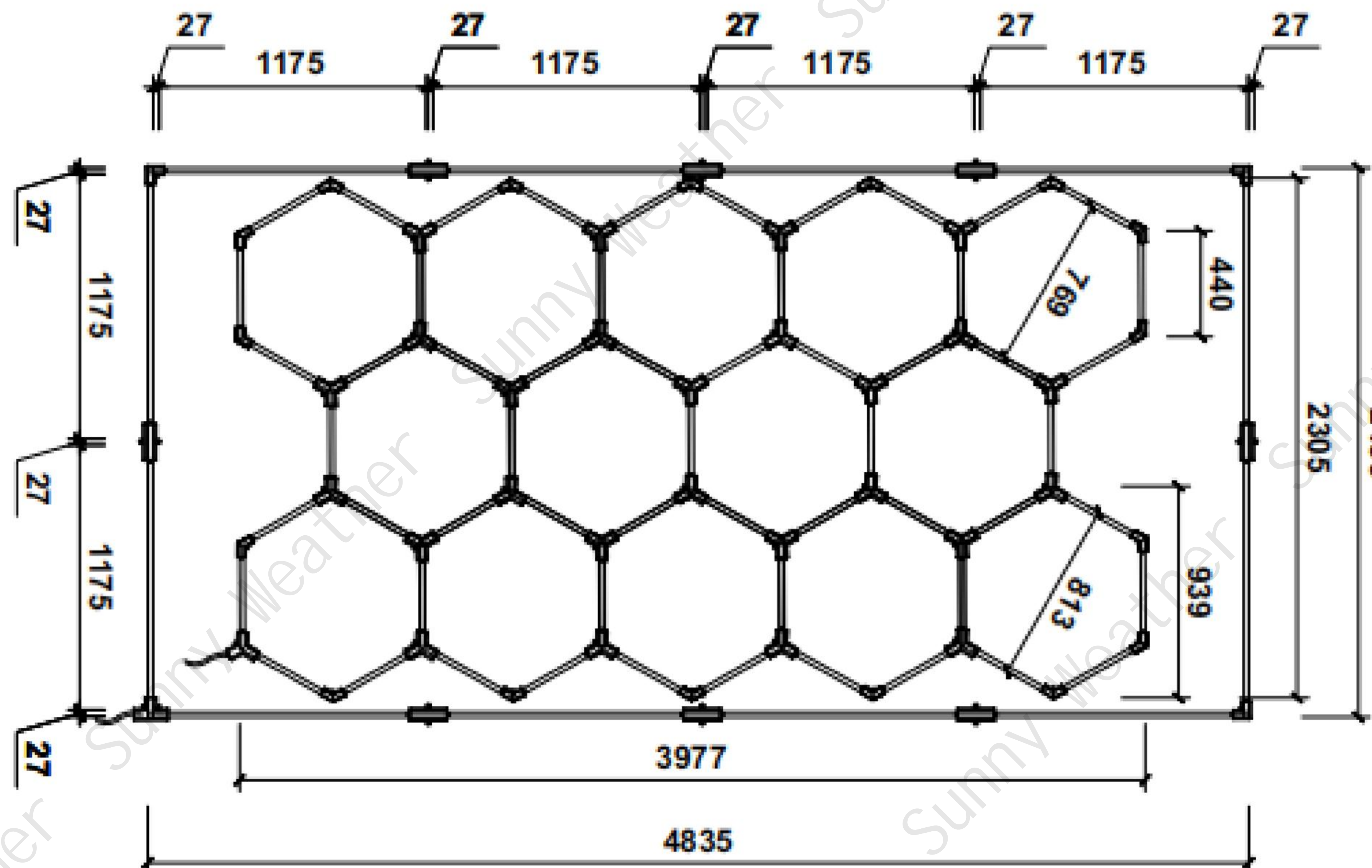

编号 NO	配件明细 Parts	数量 quantity
A	440mm灯管/Lamp tube	57
B	1175mm灯管/Lamp tube	12
C	直通/Direct connection	8
D	直角/Right angle	3
J		

编号 NO	配件明细 Parts	数量 quantity
E	T型/T-shaped	1
F	V型/V-shaped	17
G	Y型/Y-shaped	27
H	电源线/Power cord	2
I		

# LIGHTING SERIES

BBY012

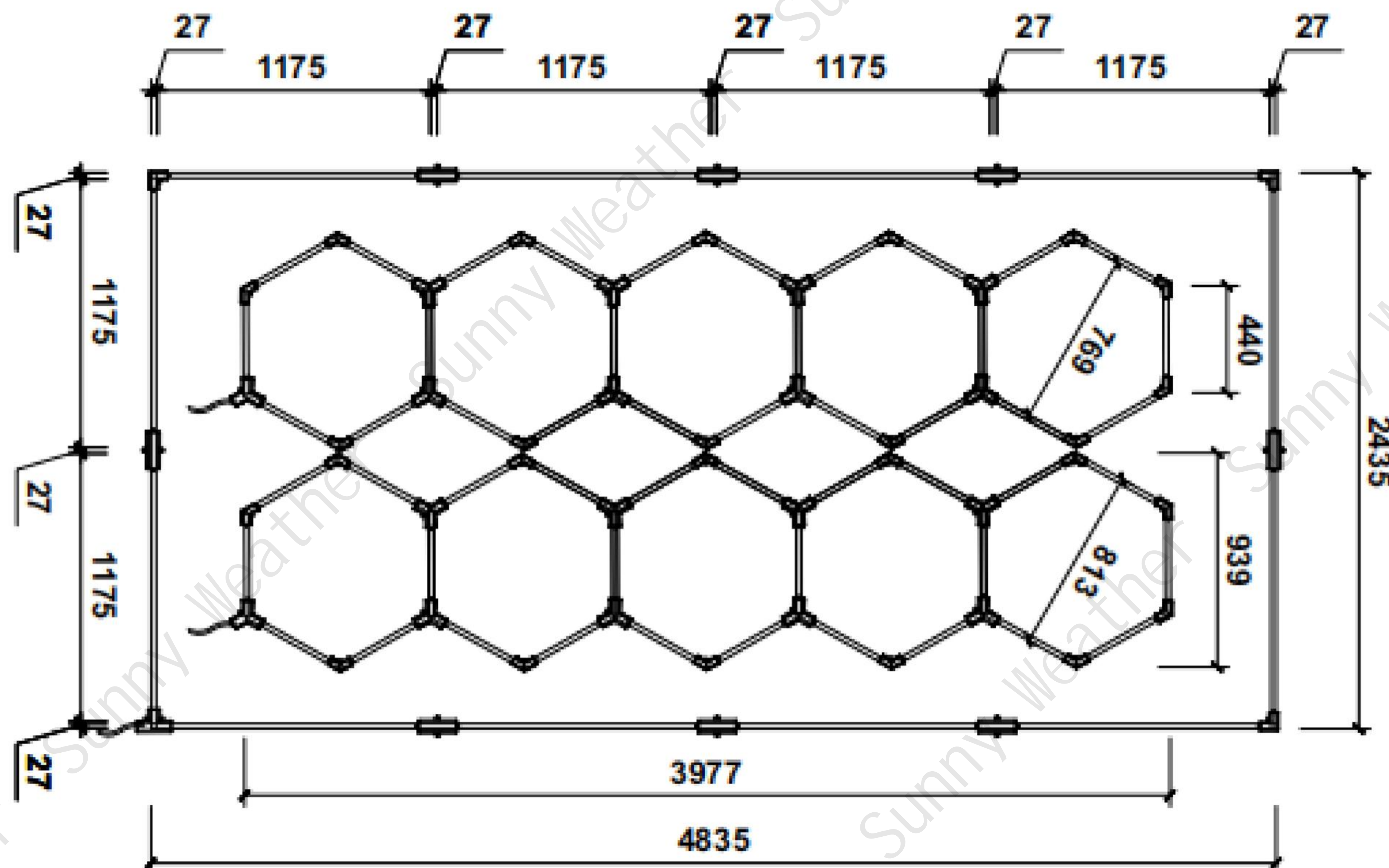

型号 Model	BBY012	通光量 Light transmission	100-120LM/W
电压 voltage	220V-110V	显色指数 Color rendering index	>90
发光面 Luminous surface	22mm	色温 Temperature	正白 (6500K) white
功率 power	568W	全套数量 Full set quantity	外框+内框 Outer frame + inner frame
尺寸 size	2435x4835mm		

编号 NO	配件明细 Parts	数量 quantity
A	440mm灯管/Lamp tube	52
B	1175mm灯管/Lamp tube	12
C	直通/Direct connection	8
D	直角/Right angle	3
J		

编号 NO	配件明细 Parts	数量 quantity
E	T型/T-shaped	1
F	V型/V-shaped	26
G	Y型/Y-shaped	18
H	电源线/Power cord	3
I		

# LIGHTING SERIES

BBY013

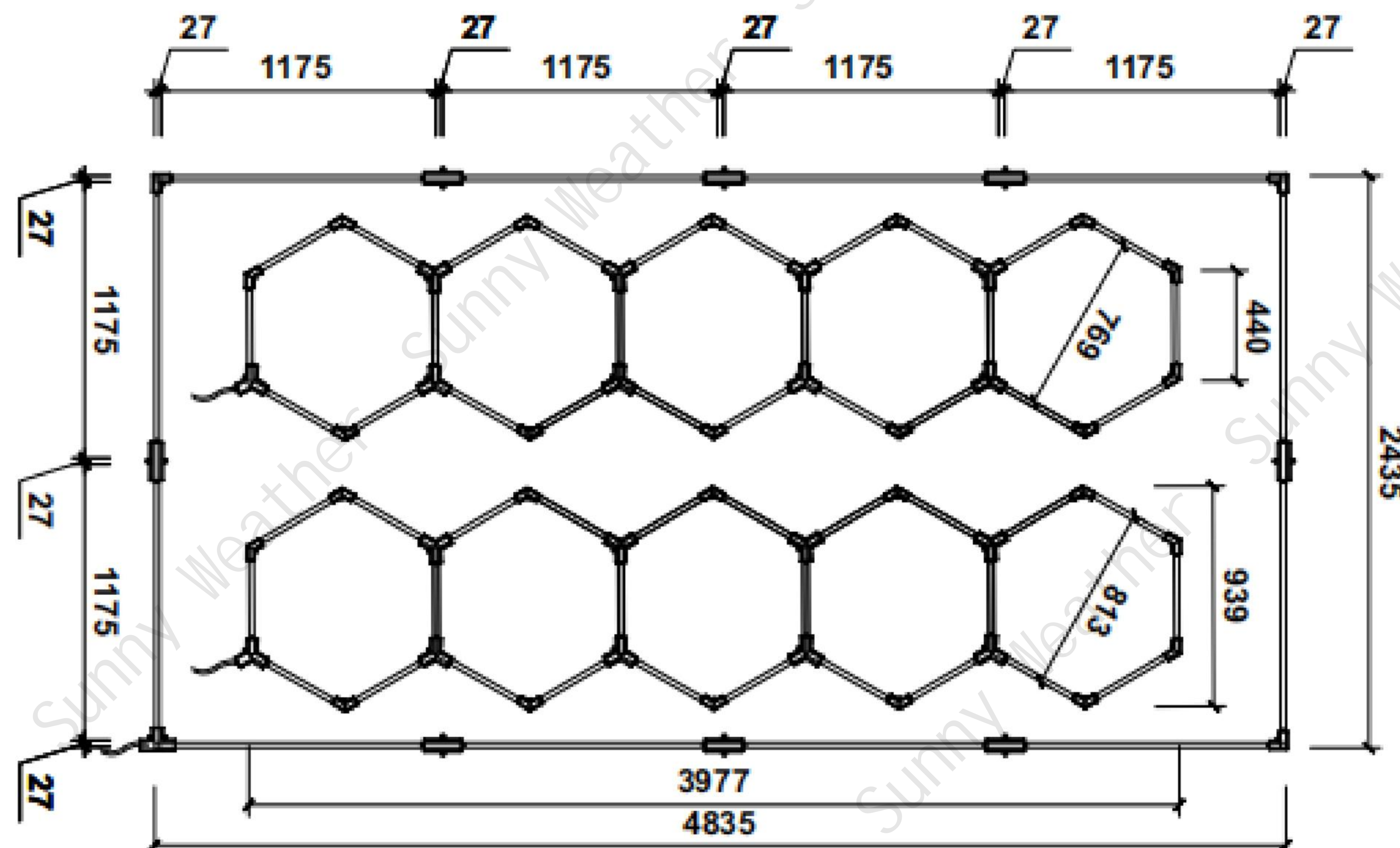

型号 Model	BBY013	通光量 Light transmission	100-120LM/W
电压 voltage	220V-110V	显色指数 Color rendering index	>90
发光面 Luminous surface	22mm	色温 Temperature	正白 (6500K) white
功率 power	568W	全套数量 Full set quantity	外框+内框 Outer frame + inner frame
尺寸 size	2435x4835mm		

编号 NO	配件明细 Parts	数量 quantity
A	440mm灯管/Lamp tube	52
B	1175mm灯管/Lamp tube	12
C	直通/Direct connection	8
D	直角/Right angle	3
J		

编号 NO	配件明细 Parts	数量 quantity
E	T型/T-shaped	1
F	V型/V-shaped	26
G	Y型/Y-shaped	18
H	电源线/Power cord	3
I		

# LIGHTING SERIES

BBY014

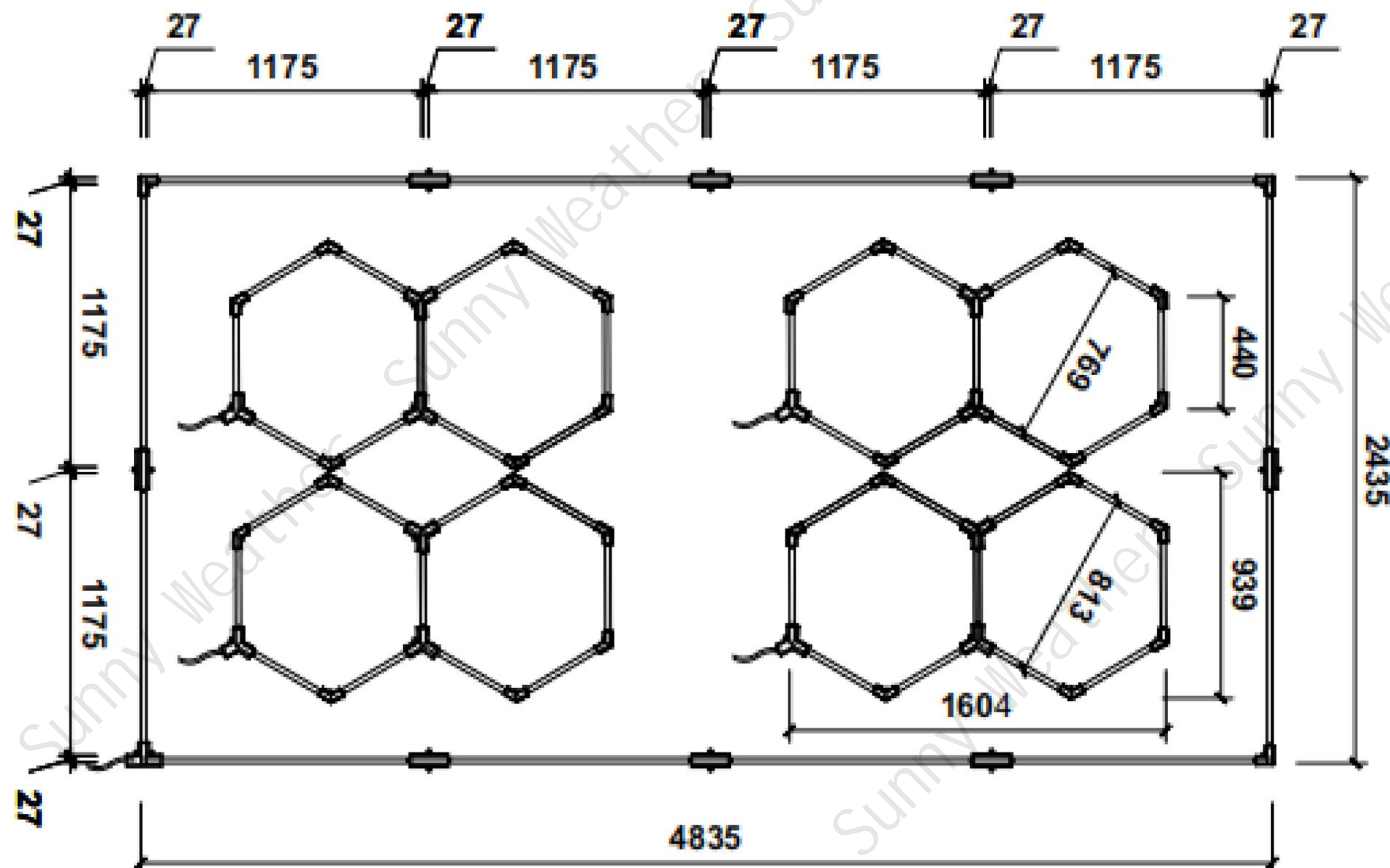

型号 Model	BBY014	通光量 Light transmission	100-120LM/W
电压 voltage	220V-110V	显色指数 Color rendering index	>90
发光面 Luminous surface	22mm	色温 Temperature	正白 (6500K) white
功率 power	512W	全套数量 Full set quantity	外框+内框 Outer frame + inner frame
尺寸 size	2435x4835mm		

编号 NO	配件明细 Parts	数量 quantity
A	440mm灯管/Lamp tube	44
B	1175mm灯管/Lamp tube	12
C	直通/Direct connection	8
D	直角/Right angle	3
J		

编号 NO	配件明细 Parts	数量 quantity
E	T型/T-shaped	1
F	V型/V-shaped	28
G	Y型/Y-shaped	12
H	电源线/Power cord	5
I		



# LIGHTING SERIES

BBY016

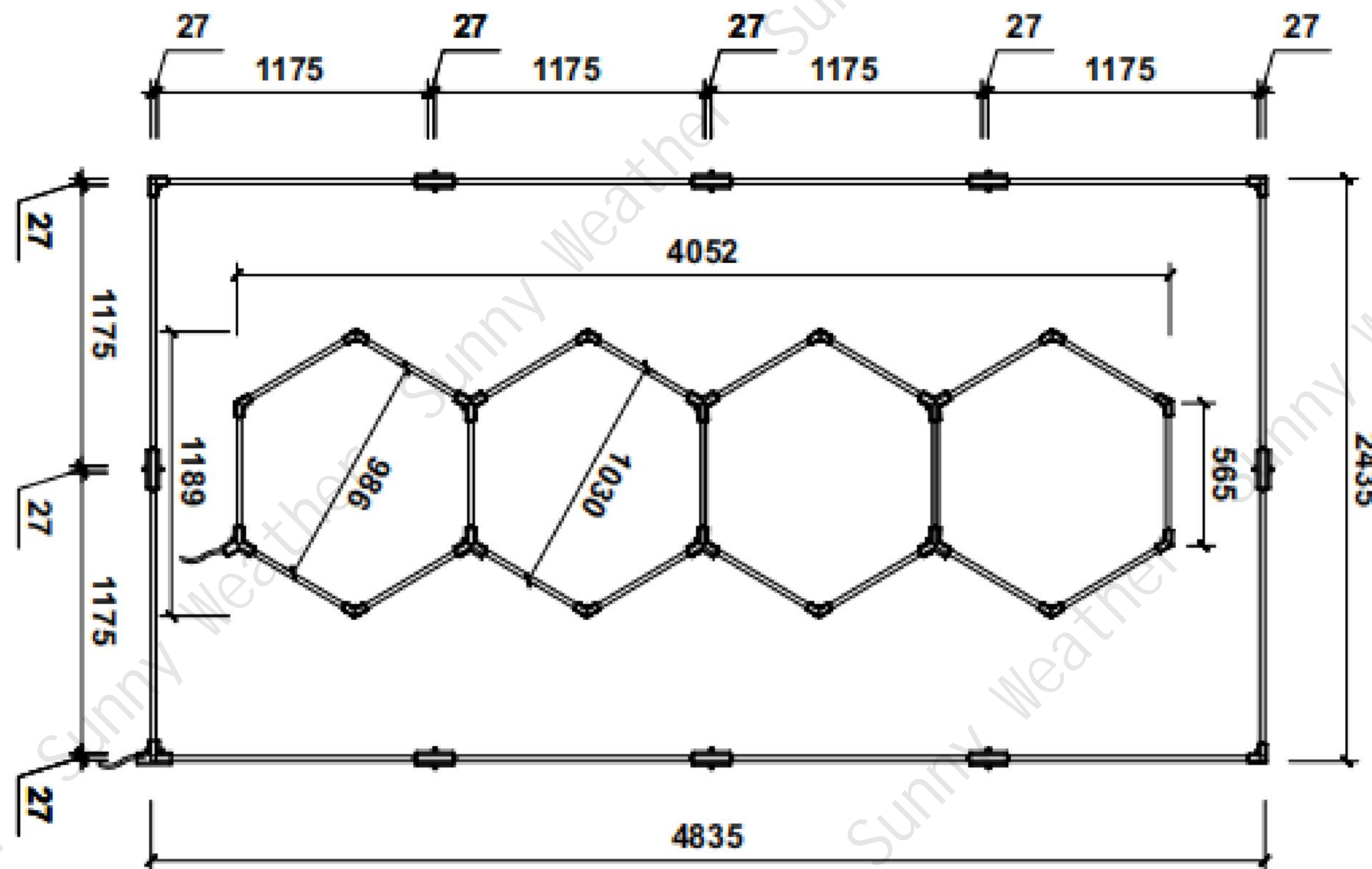

型号 Model	BBY016	通光量 Light transmission	100-120LM/W
电压 voltage	220V-110V	显色指数 Color rendering index	>90
发光面 Luminous surface	22mm	色温 Temperature	正白 (6500K) white
功率 power	372W	全套数量 Full set quantity	外框+内框 Outer frame + inner frame
尺寸 size	2435x4835mm		

编号 NO	配件明细 Parts	数量 quantity
A	565mm灯管/Lamp tube	21
B	1175mm灯管/Lamp tube	12
C	直通/Direct connection	8
D	直角/Right angle	3
J		

编号 NO	配件明细 Parts	数量 quantity
E	T型/T-shaped	1
F	V型/V-shaped	11
G	Y型/Y-shaped	7
H	电源线/Power cord	2
I		

# LIGHTING SERIES

BBY017

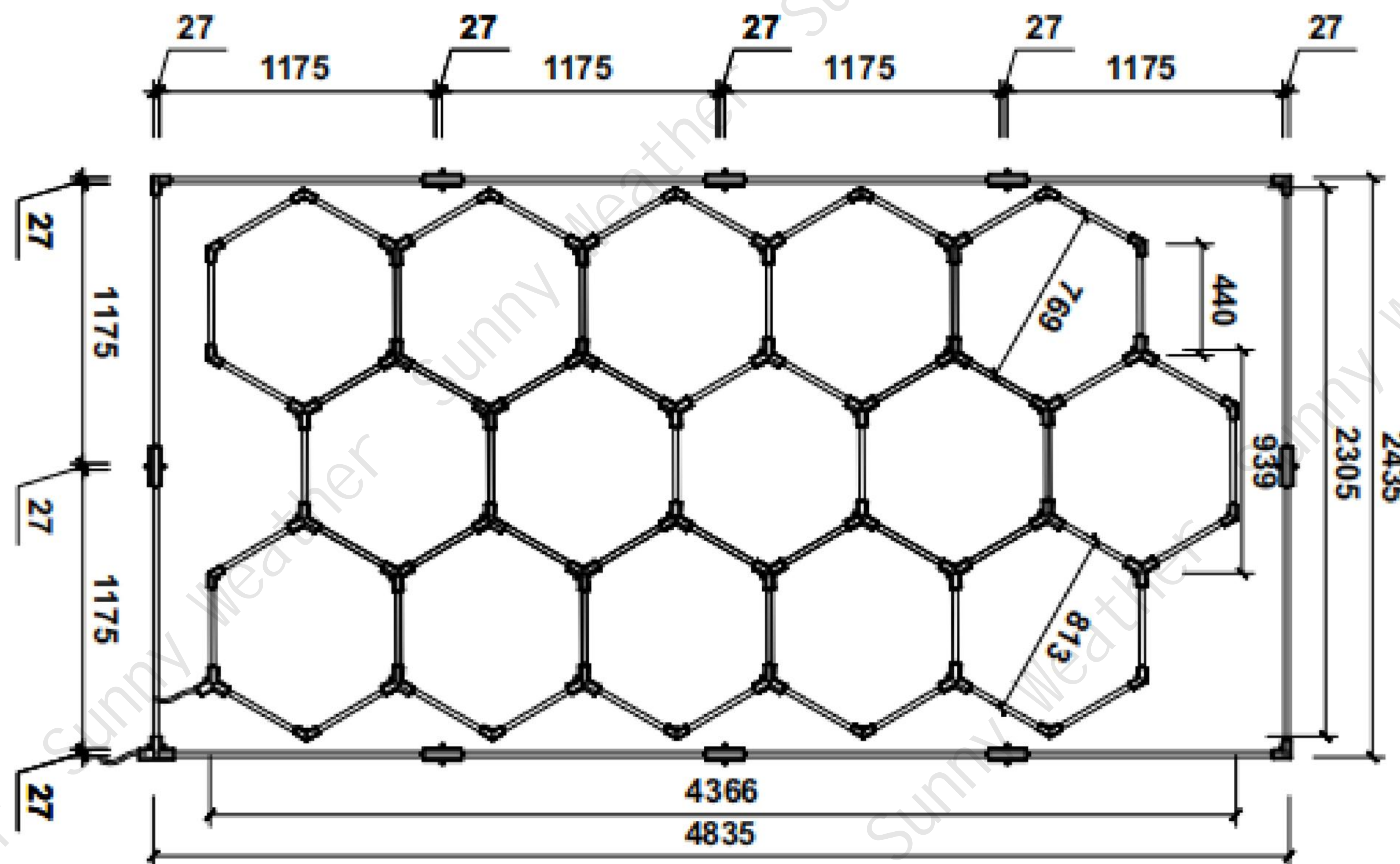

型号 Model	BBY017	通光量 Light transmission	100-120LM/W
电压 voltage	220V-110V	显色指数 Color rendering index	>90
发光面 Luminous surface	22mm	色温 Temperature	正白 (6500K) white
功率 power	624W	全套数量 Full set quantity	外框+内框 Outer frame + inner frame
尺寸 size	2435x4835mm		

编号 NO	配件明细 Parts	数量 quantity
A	440mm灯管/Lamp tube	60
B	1175mm灯管/Lamp tube	12
C	直通/Direct connection	8
D	直角/Right angle	3
J		

编号 NO	配件明细 Parts	数量 quantity
E	T型/T-shaped	1
F	V型/V-shaped	17
G	Y型/Y-shaped	29
H	电源线/Power cord	2
I		

# LIGHTING SERIES

BBY018

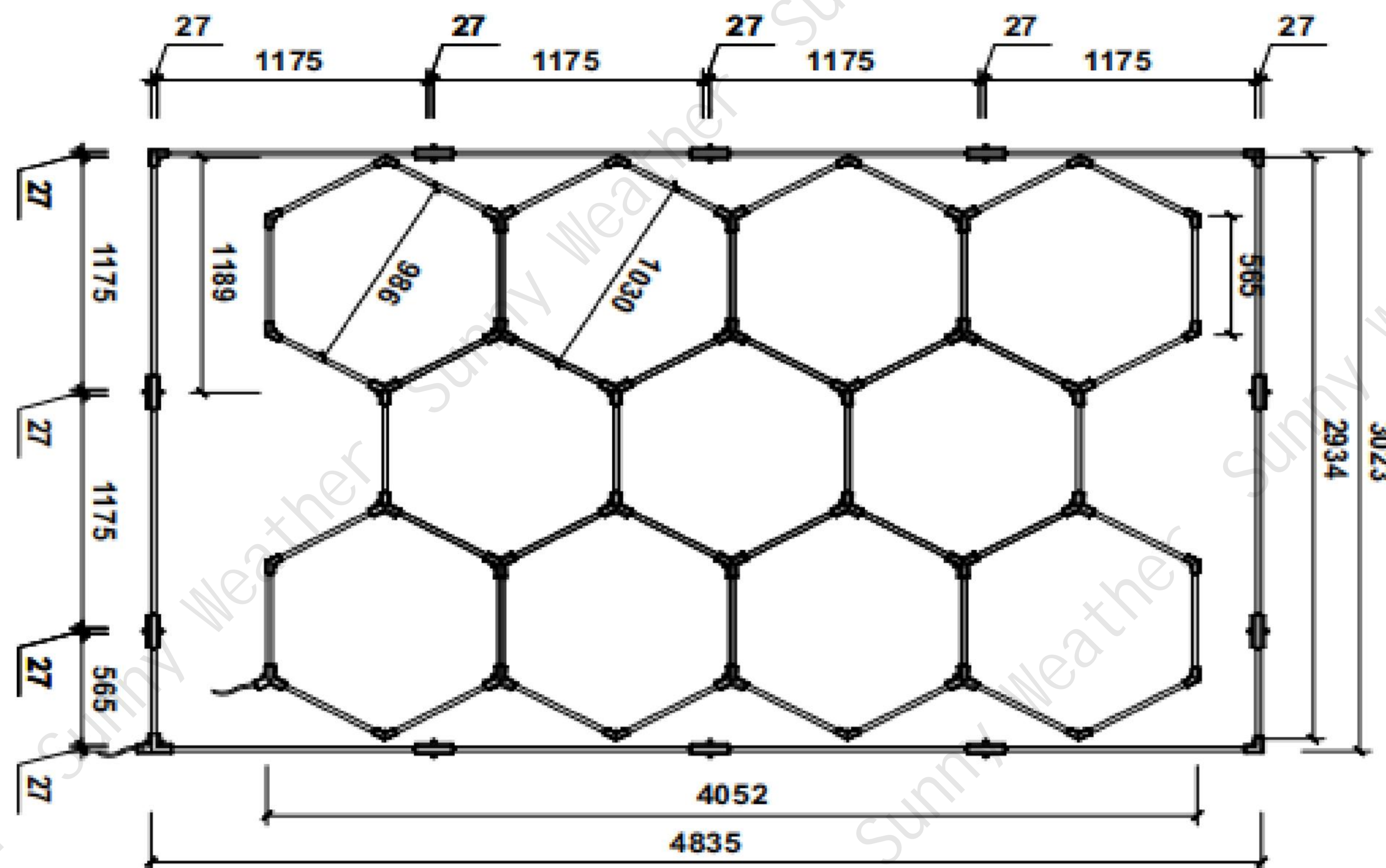
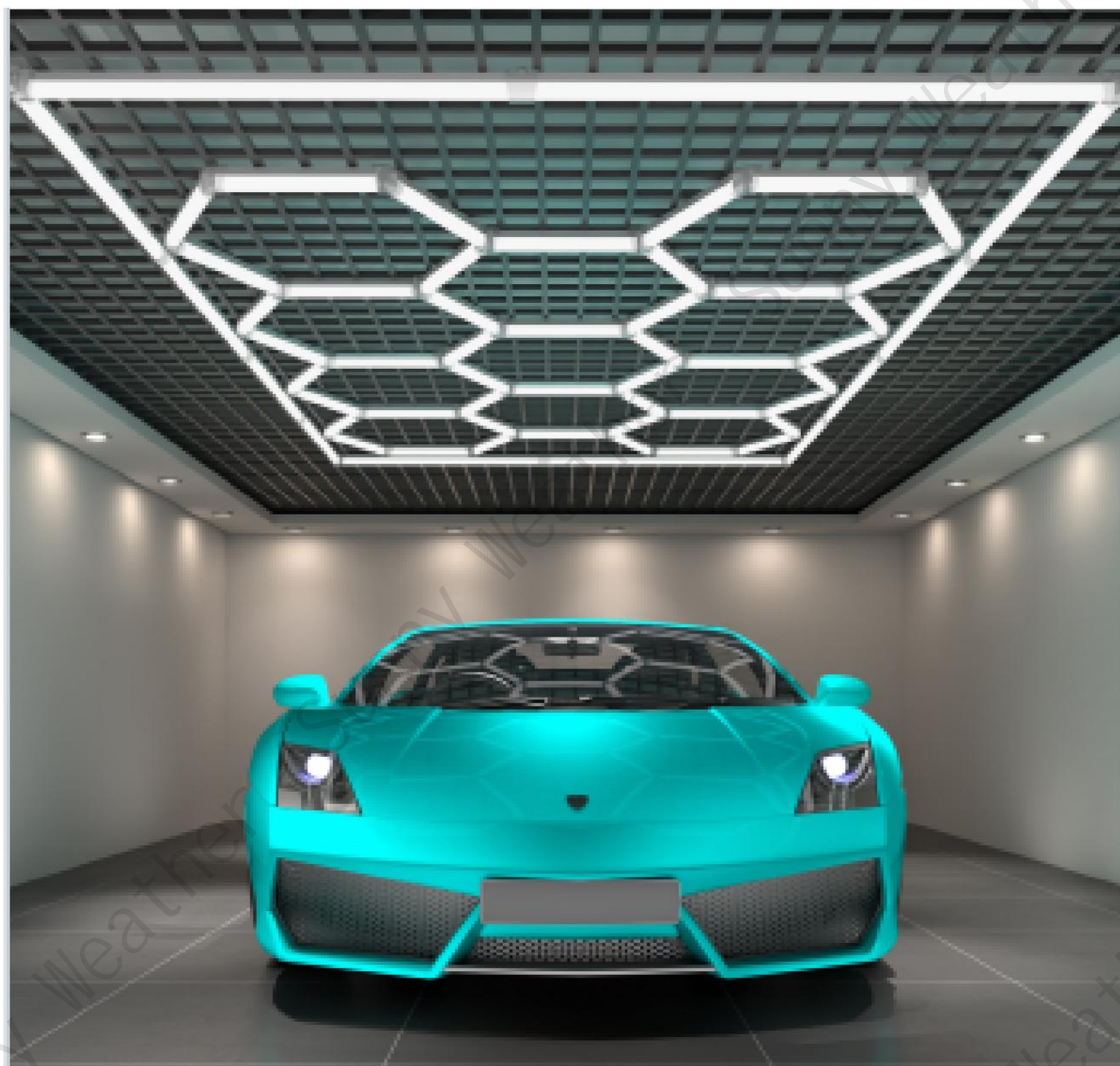

型号 Model	BBY018	通光量 Light transmission	100-120LM/W
电压 voltage	220V-110V	显色指数 Color rendering index	>90
发光面 Luminous surface	22mm	色温 Temperature	正白 (6500K) white
功率 power	588W	全套数量 Full set quantity	外框+内框 Outer frame + inner frame
尺寸 size	3023x4835mm		

编号 NO	配件明细 Parts	数量 quantity
A	565mm灯管/Lamp tube	48
B	1175mm灯管/Lamp tube	12
C	直通/Direct connection	8
D	直角/Right angle	3
J		

编号 NO	配件明细 Parts	数量 quantity
E	T型/T-shaped	1
F	V型/V-shaped	15
G	Y型/Y-shaped	21
H	电源线/Power cord	2
I		

# LIGHTING SERIES

BBT011

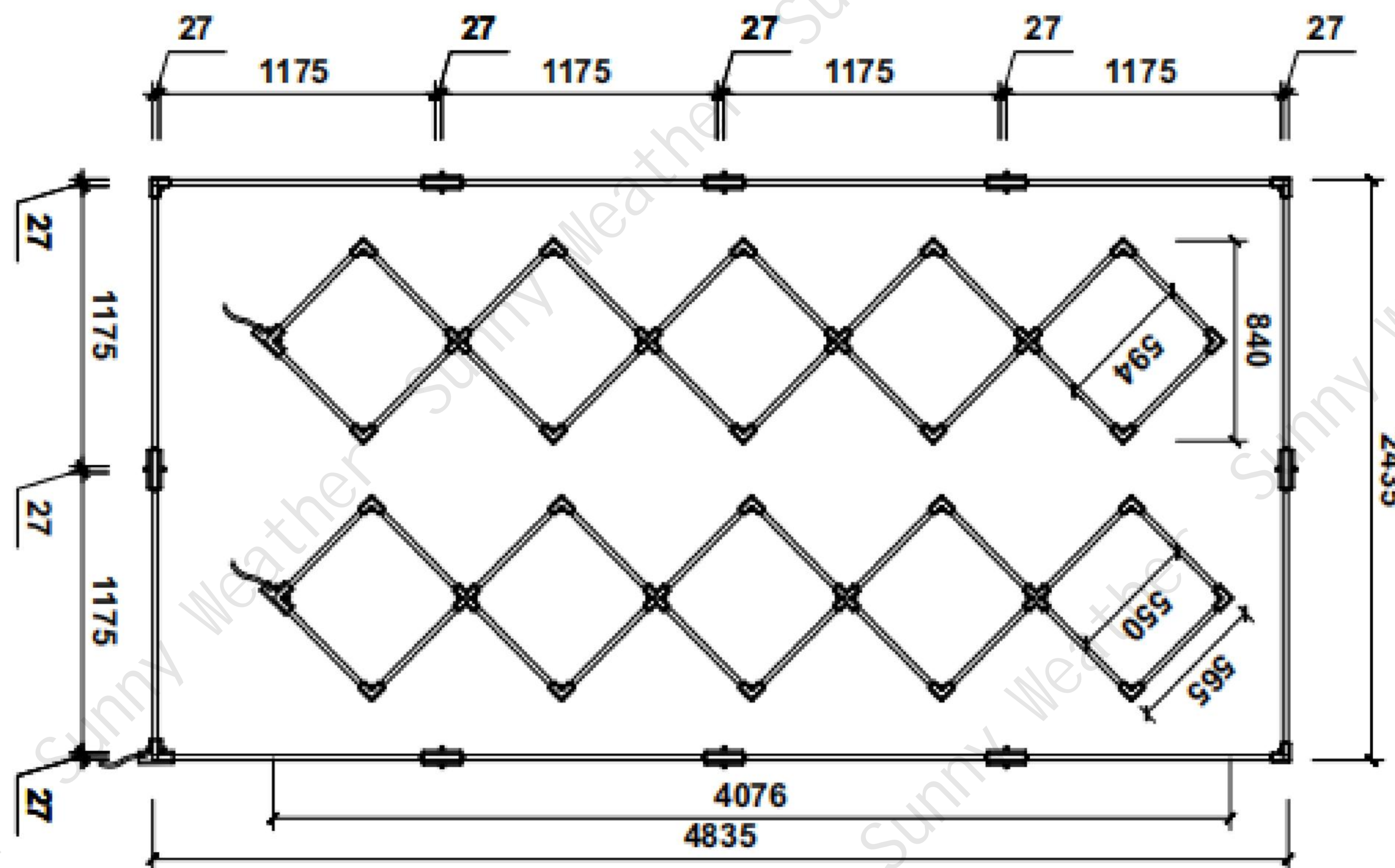

型号 Model	BBT011	通光量 Light transmission	100-120LM/W
电压 voltage	220V-110V	显色指数 Color rendering index	>90
发光面 Luminous surface	22mm	色温 Temperature	正白 (6500K) white
功率 power	524W	全套数量 Full set quantity	外框+内框 Outer frame + inner frame
尺寸 size	3023x4835mm		

编号 NO	配件明细 Parts	数量 quantity
A	565mm灯管/Lamp tube	40
B	1175mm灯管/Lamp tube	12
C	直通/Direct connection	8
D	直角/Right angle	25
J		

编号 NO	配件明细 Parts	数量 quantity
E	T型/T-shaped	3
F	+型/+ -shaped	8
H	电源线/Power cord	3

# LIGHTING SERIES

BBT012

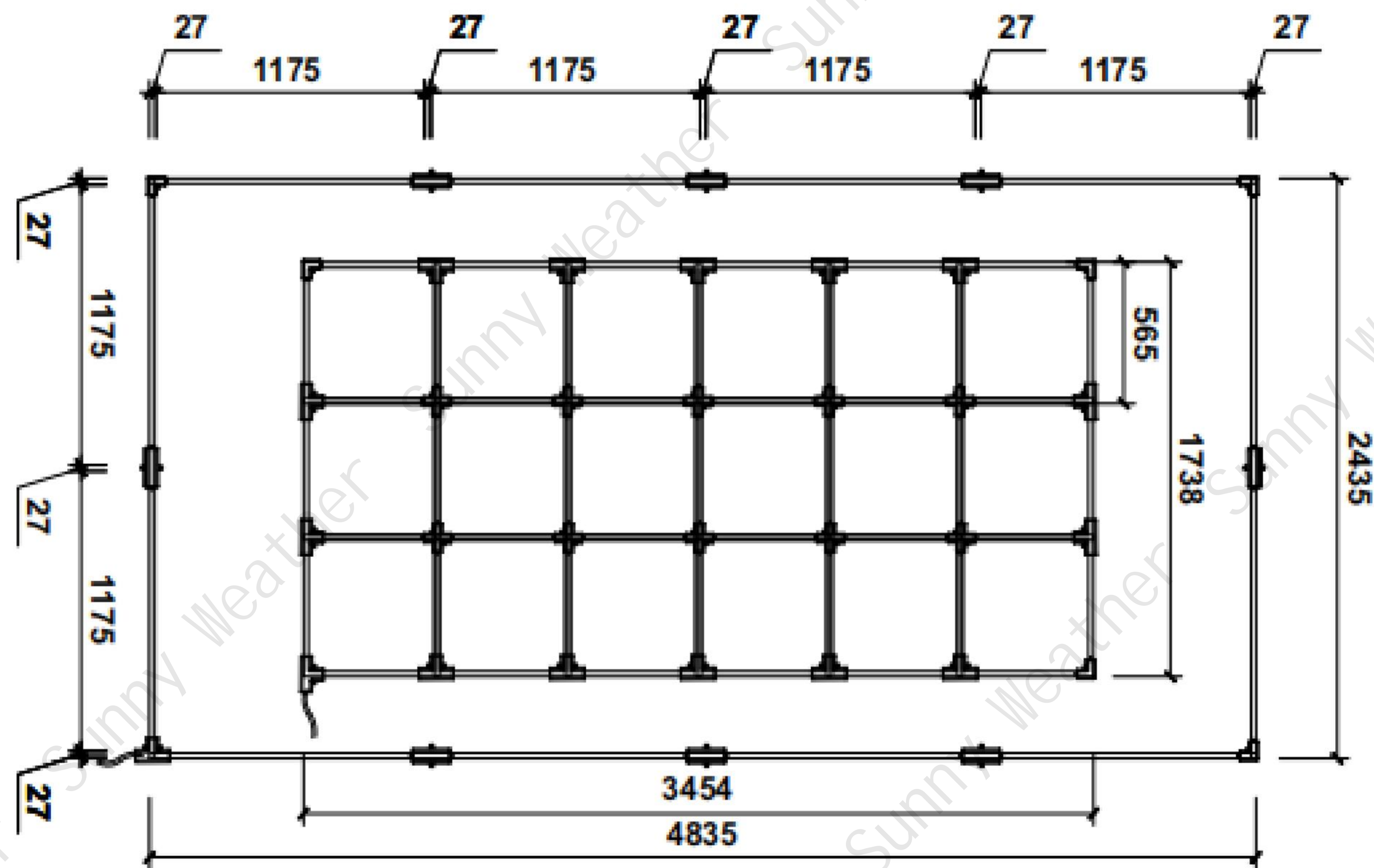

型号 Model	BBT012	通光量 Light transmission	100-120LM/W
电压 voltage	220V-110V	显色指数 Color rendering index	>90
发光面 Luminous surface	22mm	色温 Temperature	正白 (6500K) white
功率 power	564W	全套数量 Full set quantity	外框+内框 Outer frame + inner frame
尺寸 size	2435x4835mm		

编号 NO	配件明细 Parts	数量 quantity
A	565mm灯管/Lamp tube	45
B	1175mm灯管/Lamp tube	12
C	直通/Direct connection	8
D	直角/Right angle	6
J		

编号 NO	配件明细 Parts	数量 quantity
E	T型/T-shaped	15
F	+型/+ -shaped	10
H	电源线/Power cord	2

# LIGHTING SERIES

BBT013

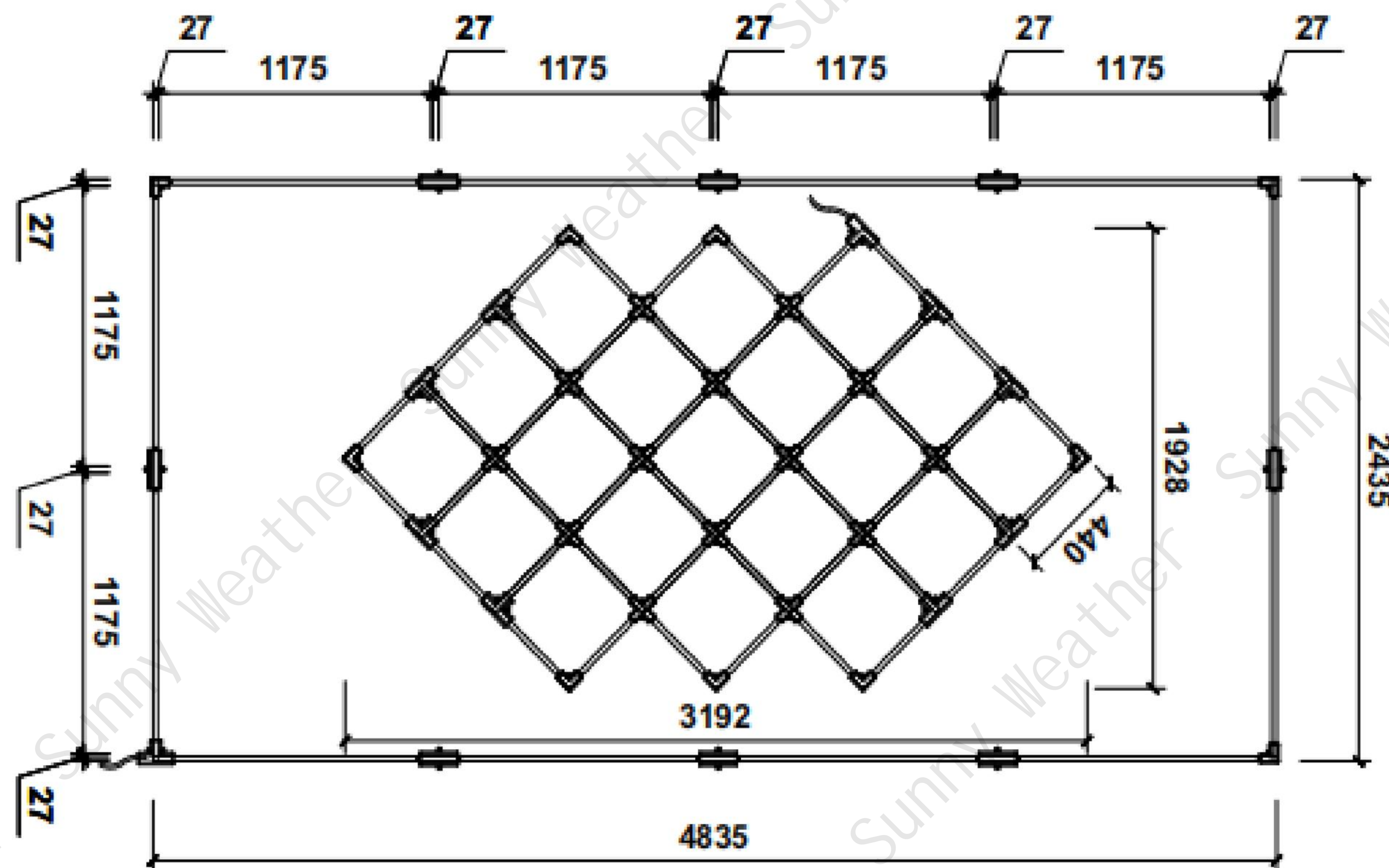

型号 Model	BBT013	通光量 Light transmission	100-120LM/W
电压 voltage	220V-110V	显色指数 Color rendering index	>90
发光面 Luminous surface	22mm	色温 Temperature	正白 (6500K) white
功率 power	540W	全套数量 Full set quantity	外框+内框 Outer frame + inner frame
尺寸 size	2435x4835mm		

编号 NO	配件明细 Parts	数量 quantity
A	440mm灯管/Lamp tube	48
B	1175mm灯管/Lamp tube	12
C	直通/Direct connection	8
D	直角/Right angle	10
J		

编号 NO	配件明细 Parts	数量 quantity
E	T型/T-shaped	10
F	+型/+ -shaped	14
H	电源线/Power cord	2

# LIGHTING SERIES

BBT014

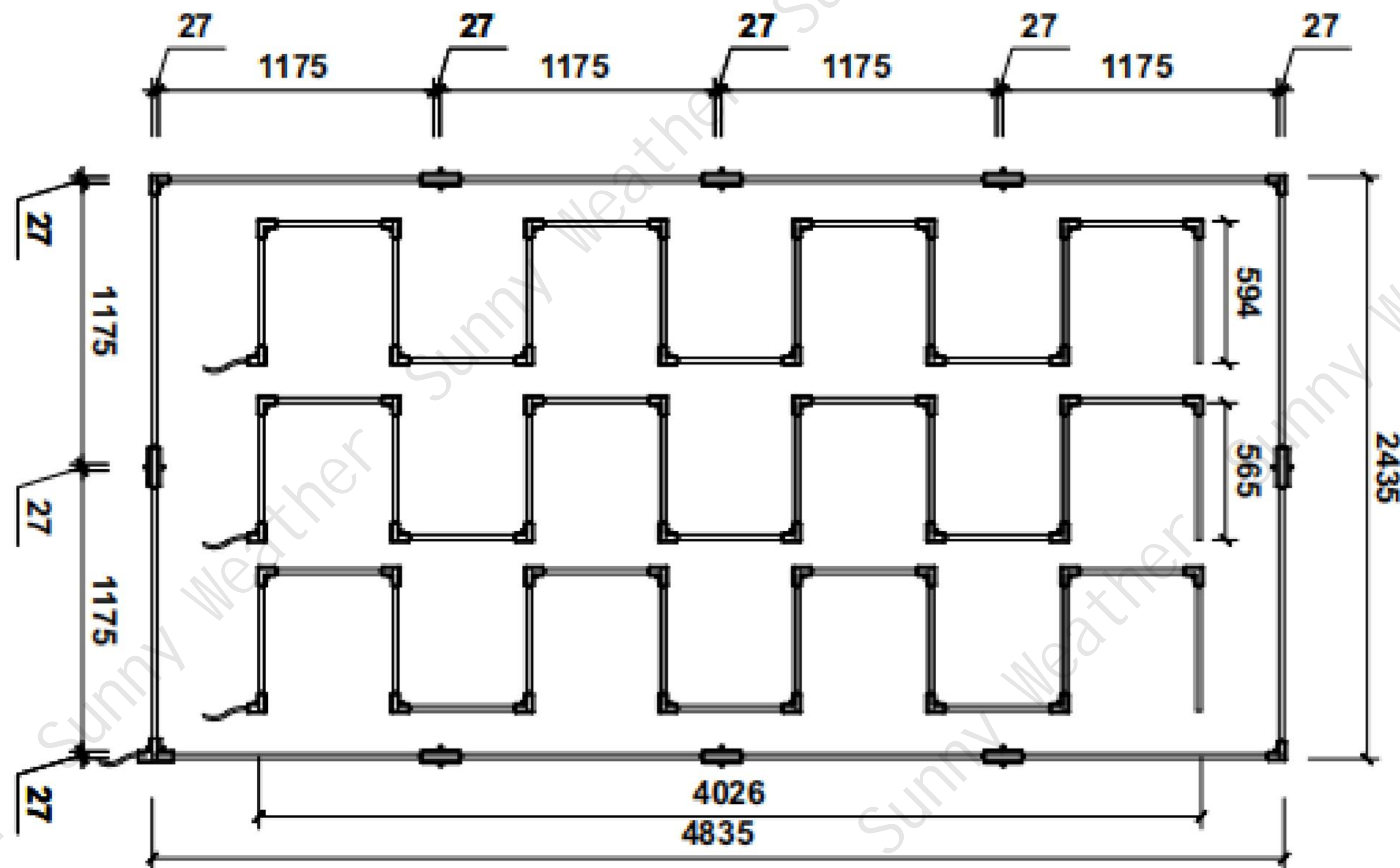

型号 Model	BBT014	通光量 Light transmission	100-120LM/W
电压 voltage	220V-110V	显色指数 Color rendering index	>90
发光面 Luminous surface	22mm	色温 Temperature	正白 (6500K) white
功率 power	564W	全套数量 Full set quantity	外框+内框 Outer frame + inner frame
尺寸 size	2435x4835mm		

编号 NO	配件明细 Parts	数量 quantity
A	565mm灯管/Lamp tube	45
B	1175mm灯管/Lamp tube	12
C	直通/Direct connection	8
D	直角/Right angle	45
J		

编号 NO	配件明细 Parts	数量 quantity
E	T型/T-shaped	1
H	电源线/Power cord	4

# LIGHTING SERIES

BBT015

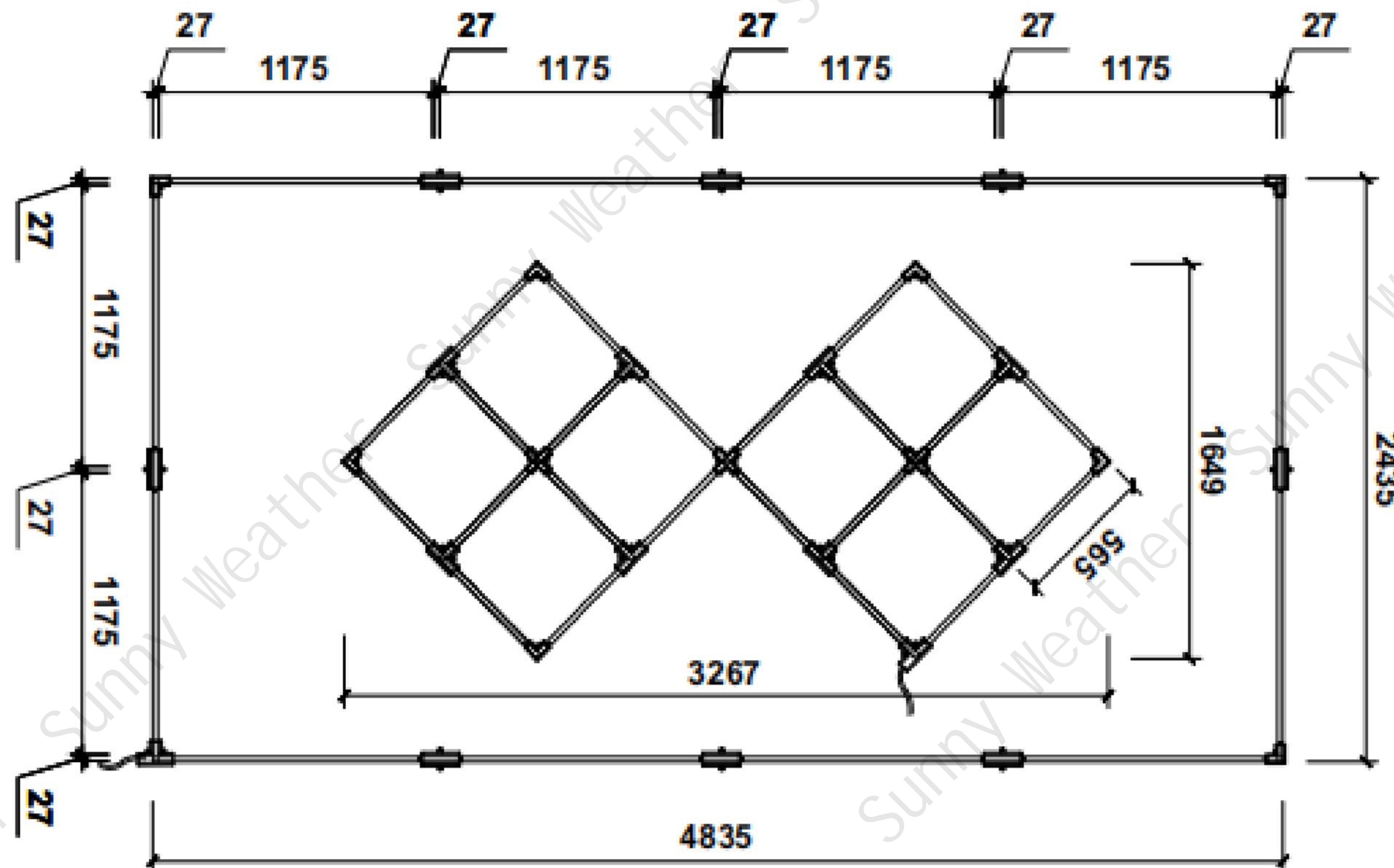

型号 Model	BBT015	通光量 Light transmission	100-120LM/W
电压 voltage	220V-110V	显色指数 Color rendering index	>90
发光面 Luminous surface	22mm	色温 Temperature	正白 (6500K) white
功率 power	396W	全套数量 Full set quantity	外框+内框 Outer frame + inner frame
尺寸 size	2435x4835mm		

编号 NO	配件明细 Parts	数量 quantity
A	565mm灯管/Lamp tube	24
B	1175mm灯管/Lamp tube	12
C	直通/Direct connection	8
D	直角/Right angle	8
J		

编号 NO	配件明细 Parts	数量 quantity
E	T型/T-shaped	10
F	+型/+ -shaped	3
H	电源线/Power cord	2

# LIGHTING SERIES

BBT016

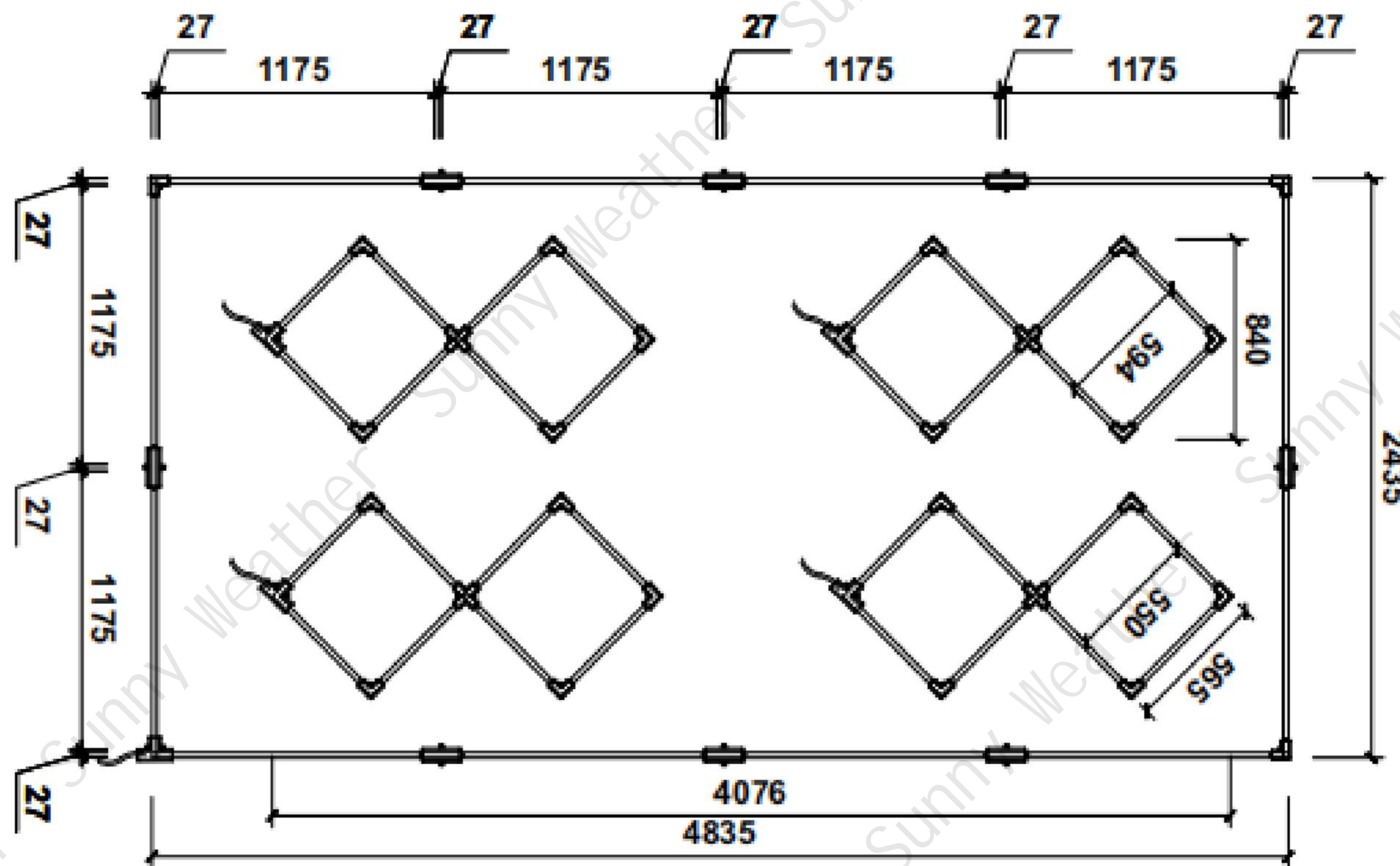

型号 Model	BBT016	通光量 Light transmission	100-120LM/W
电压 voltage	220V-110V	显色指数 Color rendering index	>90
发光面 Luminous surface	22mm	色温 Temperature	正白 (6500K) white
功率 power	460W	全套数量 Full set quantity	外框+内框 Outer frame + inner frame
尺寸 size	2435x4835mm		

编号 NO	配件明细 Parts	数量 quantity
A	565mm灯管/Lamp tube	32
B	1175mm灯管/Lamp tube	12
C	直通/Direct connection	8
D	直角/Right angle	23
J		

编号 NO	配件明细 Parts	数量 quantity
E	T型/T-shaped	5
F	+型/+ -shaped	4
H	电源线/Power cord	5

# LIGHTING SERIES

BBT017

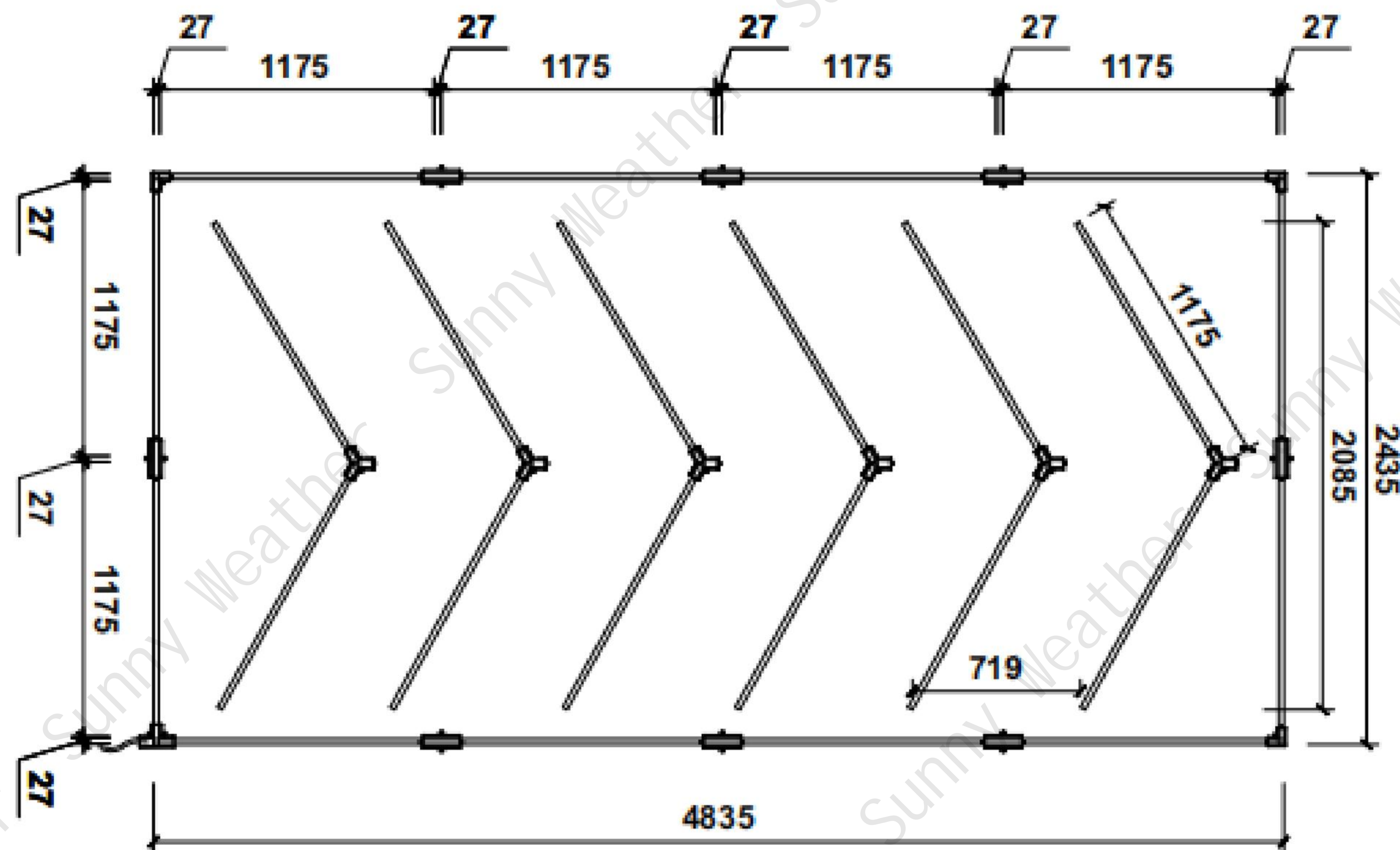

型号 Model	BBT017	通光量 Light transmission	100-120LM/W
电压 voltage	220V-110V	显色指数 Color rendering index	>90
发光面 Luminous surface	22mm	色温 Temperature	正白 (6500K) white
功率 power	408W	全套数量 Full set quantity	外框+内框 Outer frame + inner frame
尺寸 size	2435x4835mm		

编号 NO	配件明细 Parts	数量 quantity
A	1175mm灯管/Lamp tube	24
B	直通/Direct connection	8
C	直角/Right angle	3
D		
J		

编号 NO	配件明细 Parts	数量 quantity
E	T型/T-shaped	1
F	Y型/Y-shaped	6
H	电源线/Power cord	7

# LIGHTING SERIES

BBT018

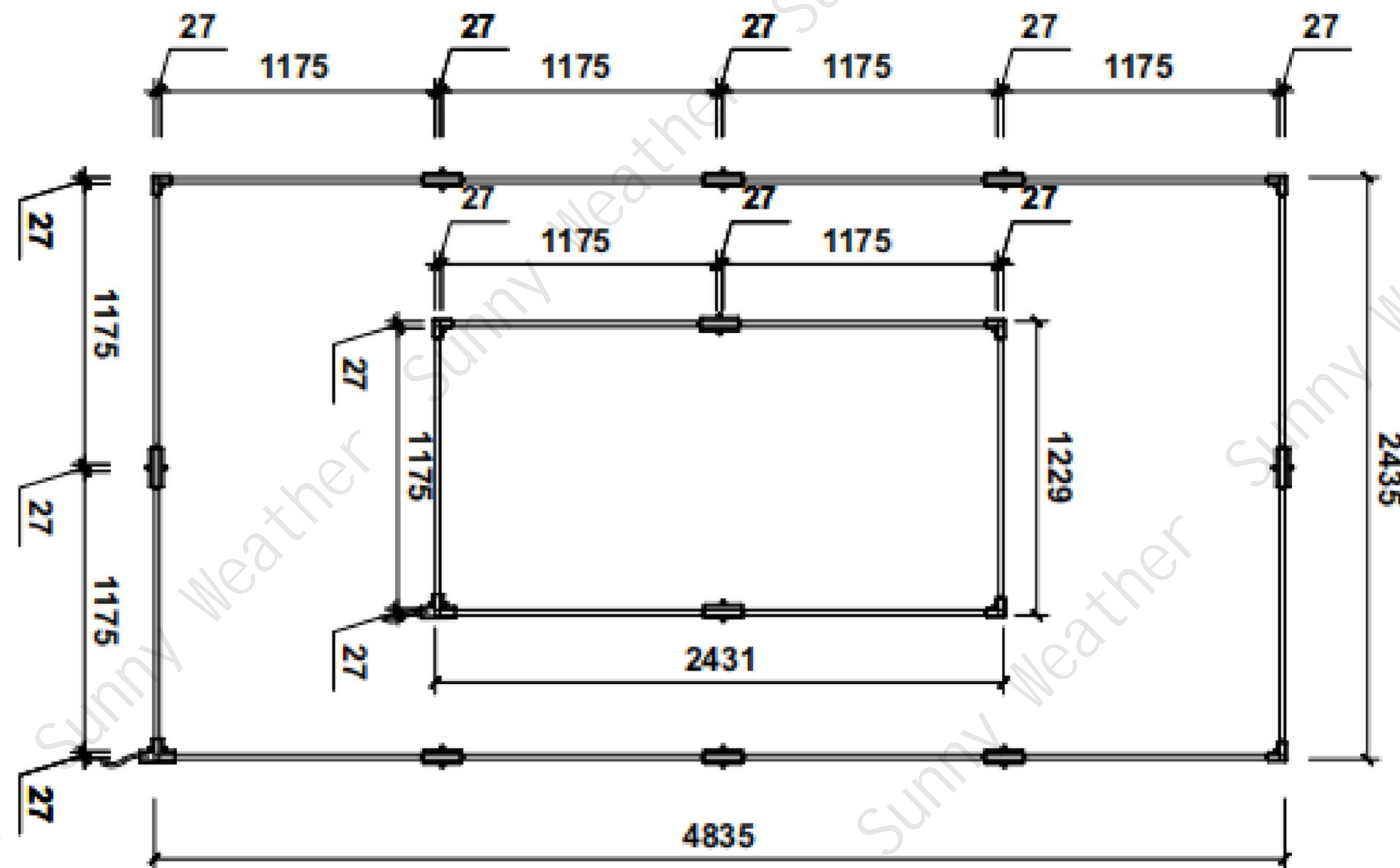

型号 Model	BBT018	通光量 Light transmission	100-120LM/W
电压 voltage	220V-110V	显色指数 Color rendering index	>90
发光面 Luminous surface	22mm	色温 Temperature	正白 (6500K) white
功率 power	306W	全套数量 Full set quantity	外框+内框 Outer frame + inner frame
尺寸 size	2435x4835mm		

编号 NO	配件明细 Parts	数量 quantity
A	1175mm灯管/Lamp tube	18
B	直通/Direct connection	10
C	直角/Right angle	6
D		
J		

编号 NO	配件明细 Parts	数量 quantity
E	T型/T-shaped	2
H	电源线/Power cord	2

# LIGHTING SERIES

BBT019

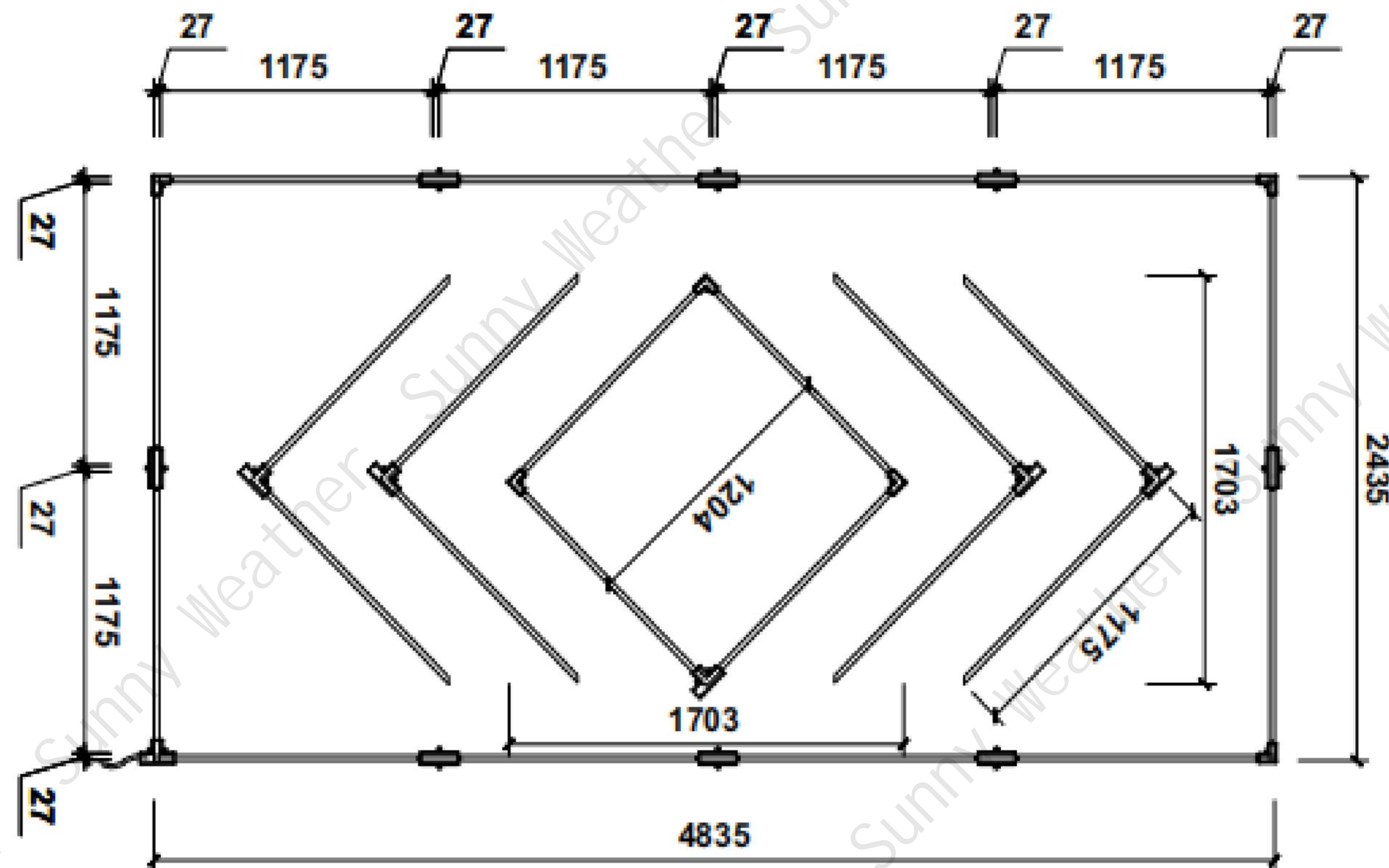

型号 Model	BBT019	通光量 Light transmission	100-120LM/W
电压 voltage	220V-110V	显色指数 Color rendering index	>90
发光面 Luminous surface	22mm	色温 Temperature	正白 (6500K) white
功率 power	408W	全套数量 Full set quantity	外框+内框 Outer frame + inner frame
尺寸 size	2435x4835mm		

编号 NO	配件明细 Parts	数量 quantity
A	1175mm灯管/Lamp tube	24
B	直通/Direct connection	8
C	直角/Right angle	6
D		
J		

编号 NO	配件明细 Parts	数量 quantity
E	T型/T-shaped	6
H	电源线/Power cord	6

# LIGHTING SERIES

BBT020

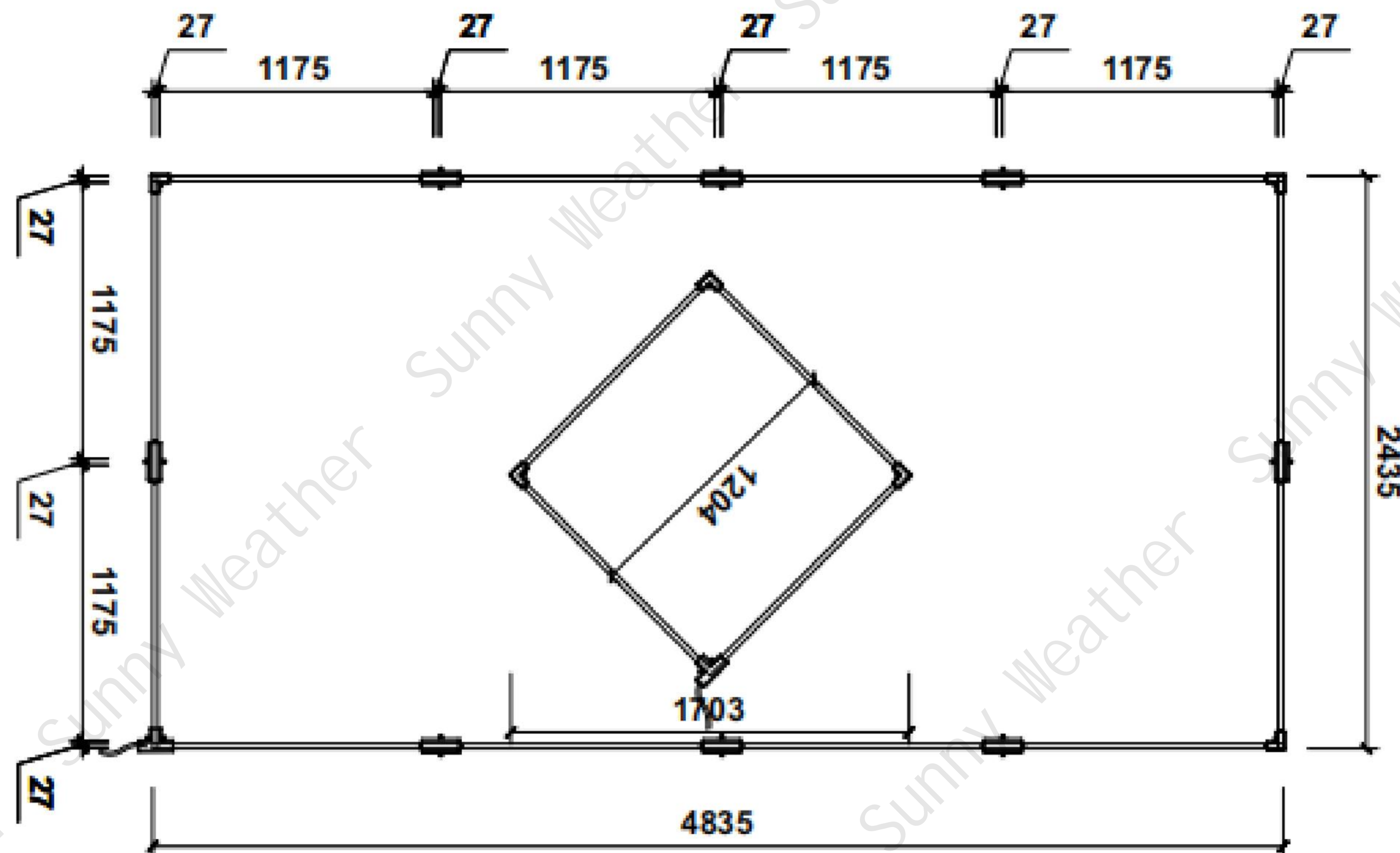

型号 Model	BBT020	通光量 Light transmission	100-120LM/W
电压 voltage	220V-110V	显色指数 Color rendering index	>90
发光面 Luminous surface	22mm	色温 Temperature	正白 (6500K) white
功率 power	272W	全套数量 Full set quantity	外框+内框 Outer frame + inner frame
尺寸 size	2435x4835mm		

编号 NO	配件明细 Parts	数量 quantity
A	1175mm灯管/Lamp tube	16
B	直通/Direct connection	8
C	直角/Right angle	6
D		
J		

编号 NO	配件明细 Parts	数量 quantity
E	T型/T-shaped	2
H	电源线/Power cord	2

# LIGHTING SERIES

BBT021

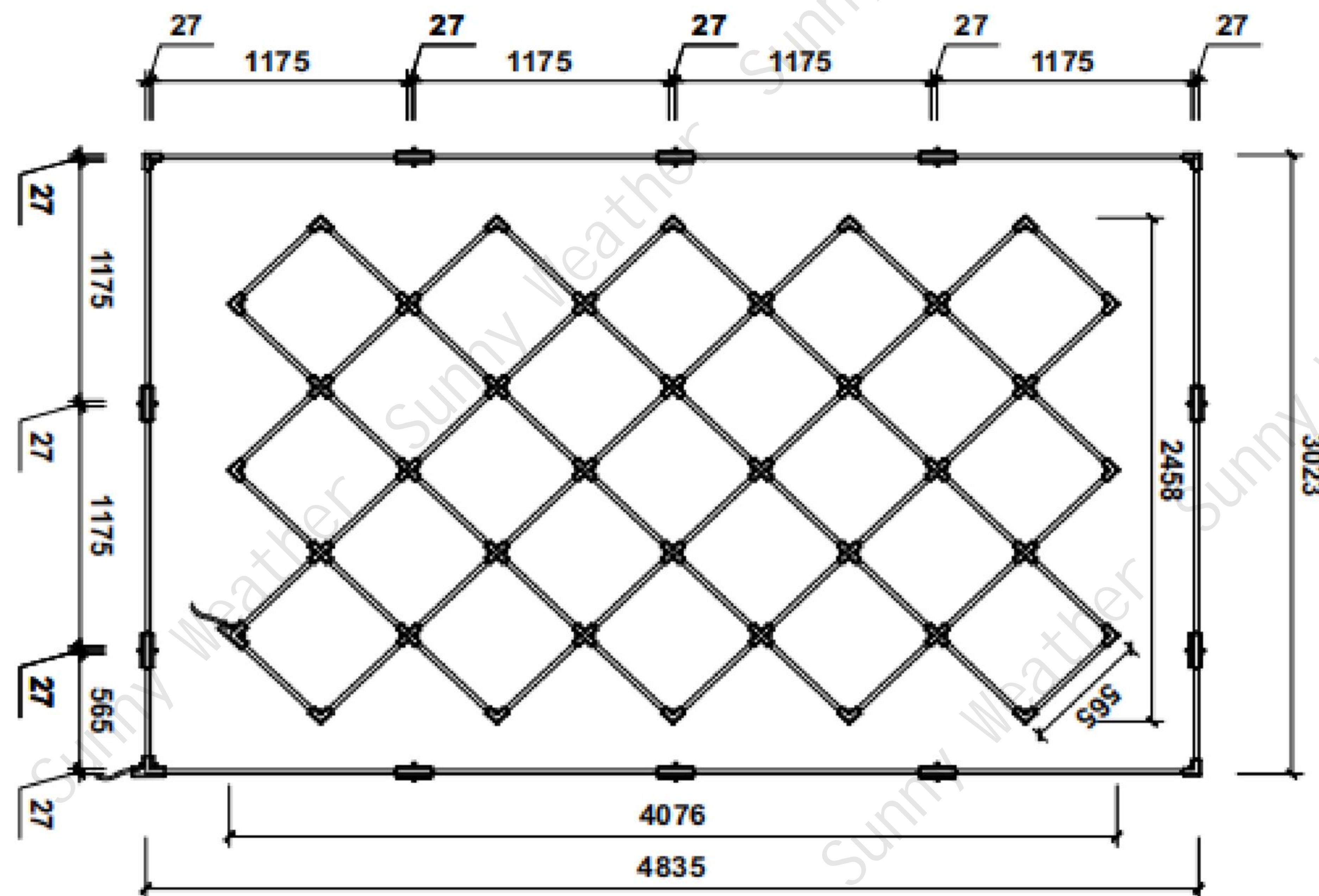
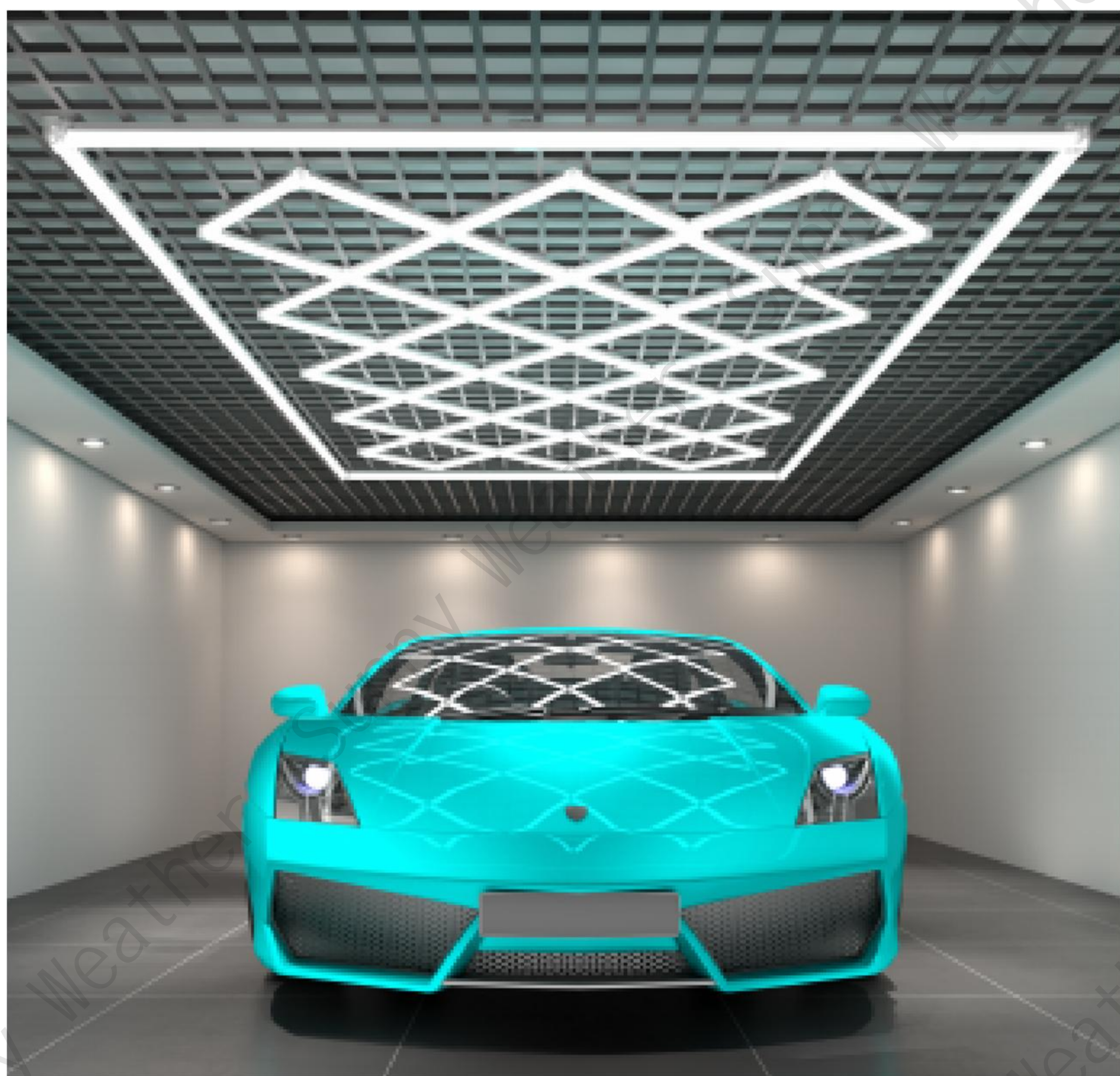

型号 Model	BBT021	通光量 Light transmission	100-120LM/W
电压 voltage	220V-110V	显色指数 Color rendering index	>90
发光面 Luminous surface	22mm	色温 Temperature	正白 (6500K) white
功率 power	700W	全套数量 Full set quantity	外框+内框 Outer frame + inner frame
尺寸 size	3023x4835mm		

编号 NO	配件明细 Parts	数量 quantity
A	1175mm灯管/Lamp tube	12
B	565mm灯管/Lamp tube	62
C	直通/Direct connection	10
D	直角/Right angle	18
J		

编号 NO	配件明细 Parts	数量 quantity
E	T型/T-shaped	2
E	+型/+ -shaped	22
H	电源线/Power cord	2

# LIGHTING SERIES

BBT022



型号 Model	BBT022	通光量 Light transmission	100-120LM/W
电压 voltage	220V-110V	显色指数 Color rendering index	>90
发光面 Luminous surface	22mm	色温 Temperature	正白 (6500K) white
功率 power	458W	全套数量 Full set quantity	外框+内框 Outer frame + inner frame
尺寸 size	3435x4835mm		

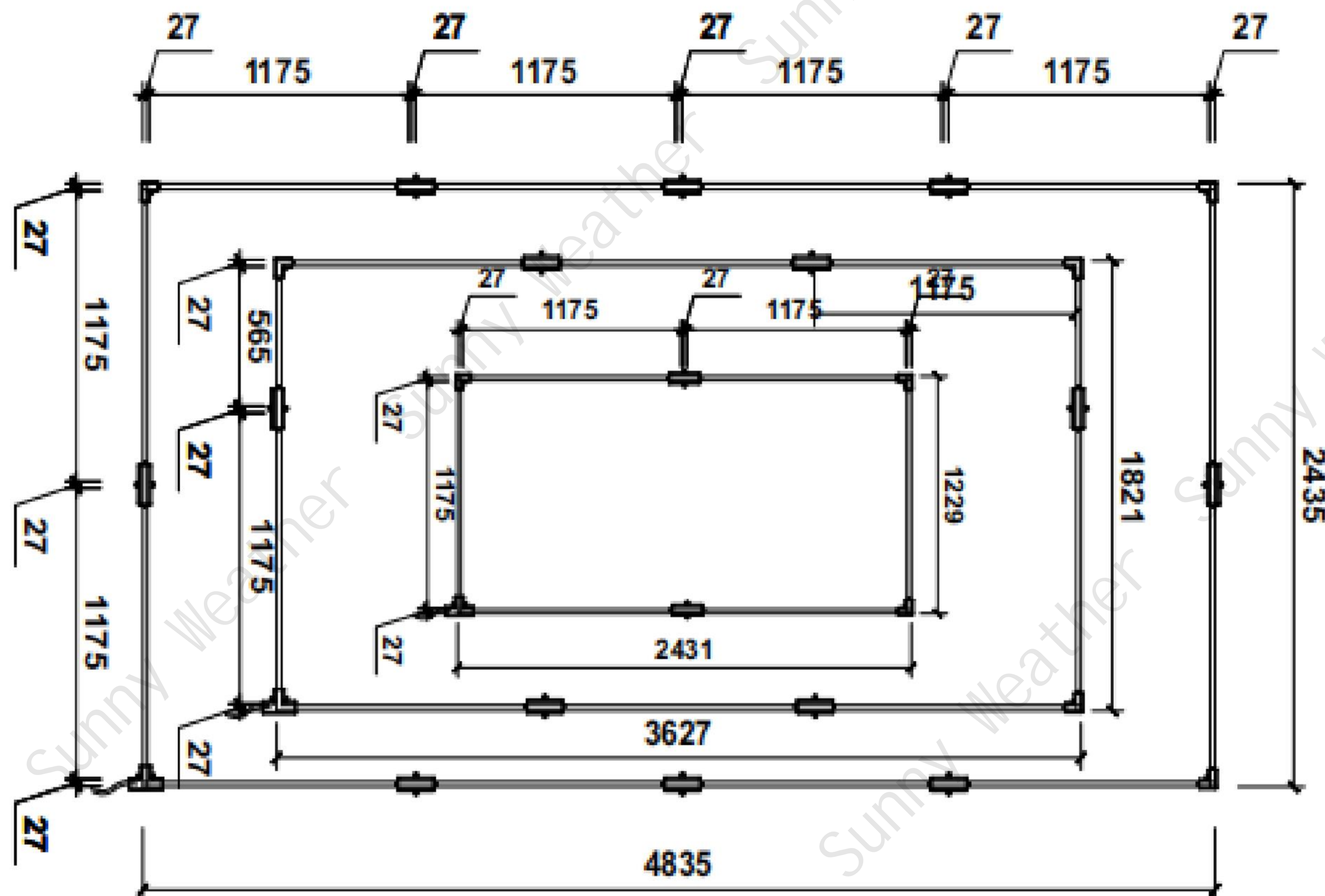

编号 NO	配件明细 Parts	数量 quantity
A	1175mm灯管/Lamp tube	26
B	565mm灯管/Lamp tube	2
C	直通/Direct connection	16
D	直角/Right angle	9
J		

编号 NO	配件明细 Parts	数量 quantity
E	T型/T-shaped	3
H	电源线/Power cord	3

# LIGHTING SERIES

BBT023

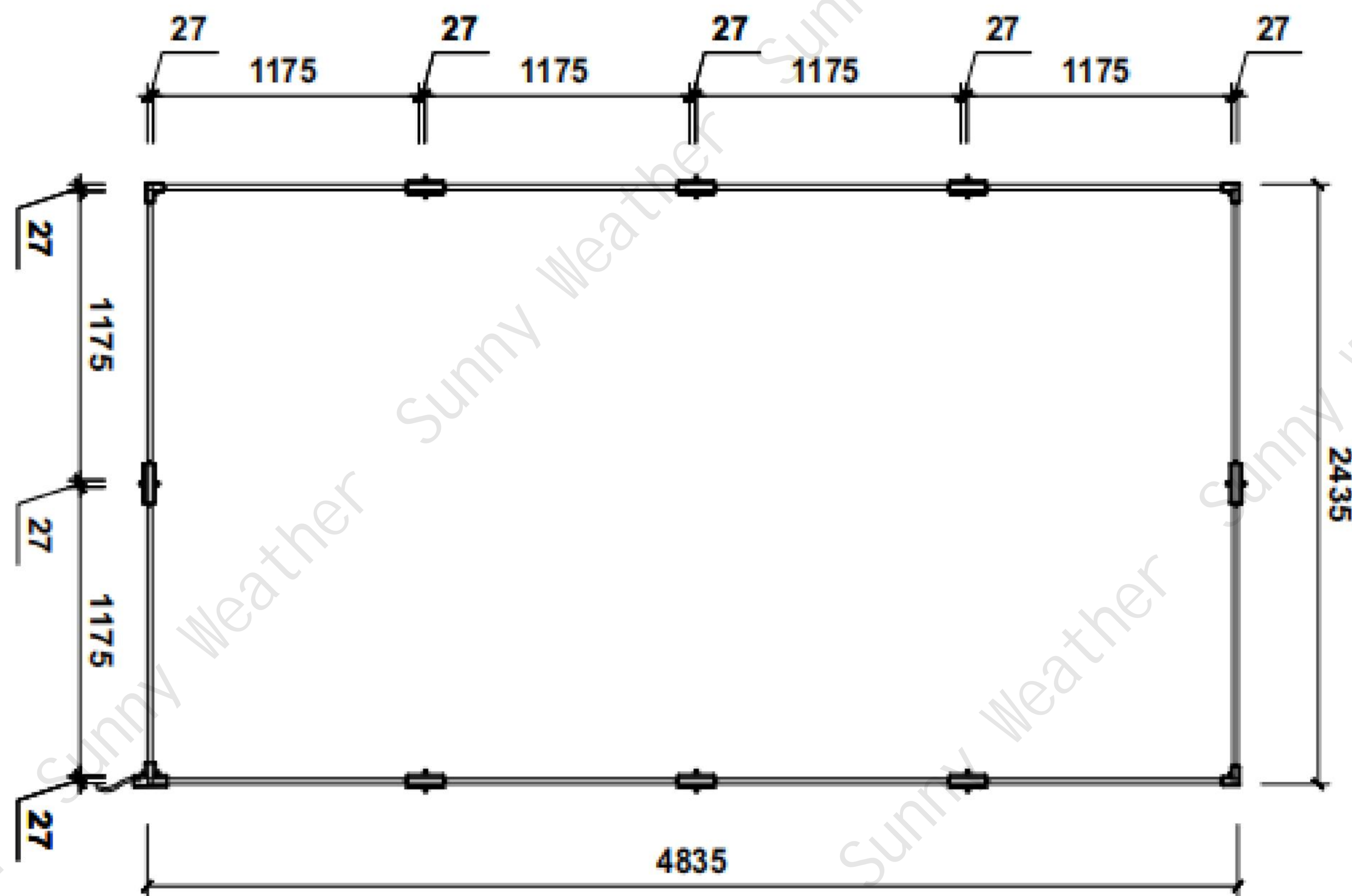

型号 Model	BBT023	通光量 Light transmission	100-120LM/W
电压 voltage	220V-110V	显色指数 Color rendering index	>90
发光面 Luminous surface	22mm	色温 Temperature	正白 (6500K) white
功率 power	204W	全套数量 Full set quantity	外框+内框 Outer frame + inner frame
尺寸 size	2435x4835mm		

编号 NO	配件明细 Parts	数量 quantity
A	1175mm灯管/Lamp tube	12
B	直通/Direct connection	8
C	直角/Right angle	3
D		
J		

编号 NO	配件明细 Parts	数量 quantity
E	T型/T-shaped	1
H	电源线/Power cord	1

# LIGHTING SERIES

BBT024

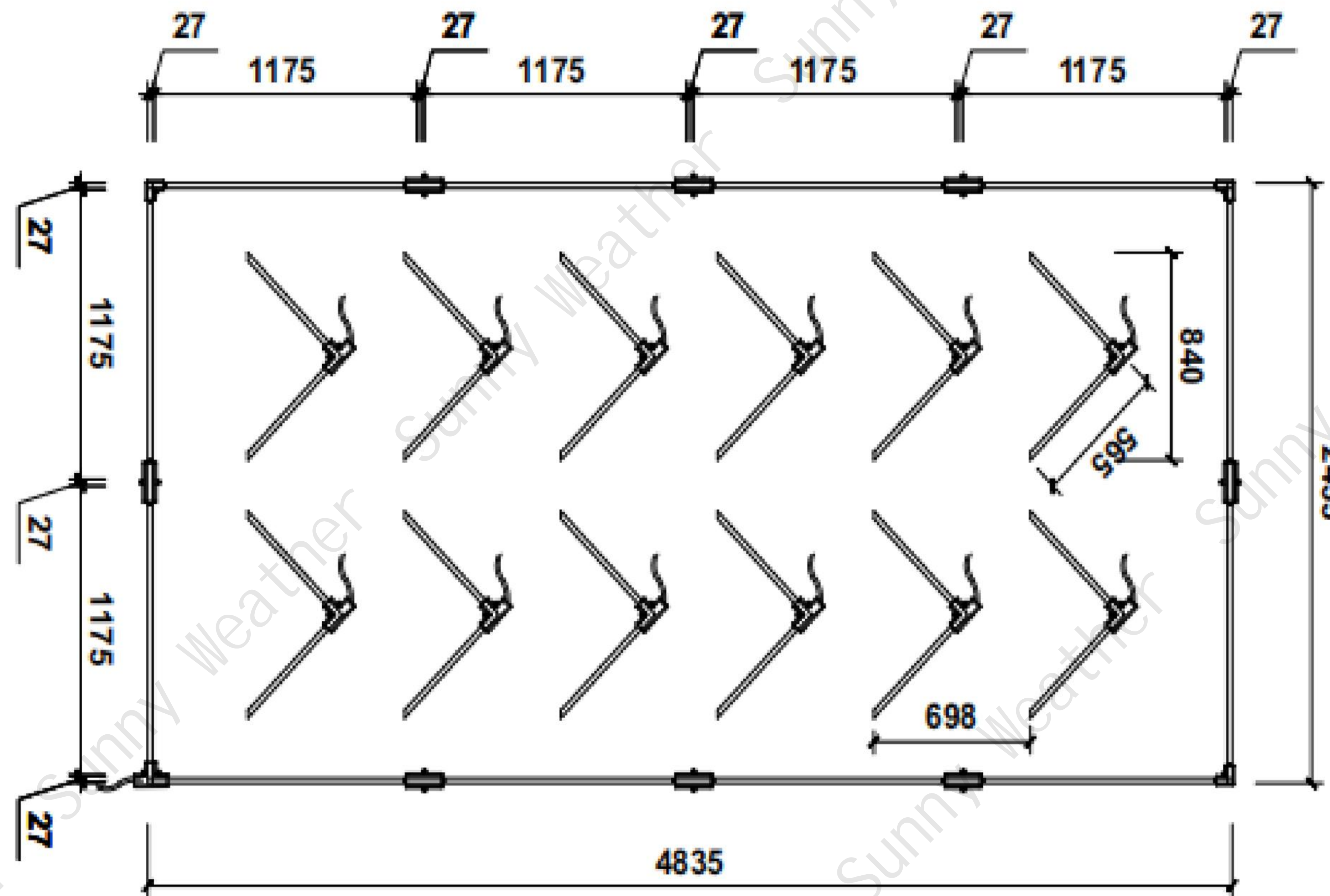

型号 Model	BBT024	通光量 Light transmission	100-120LM/W
电压 voltage	220V-110V	显色指数 Color rendering index	>90
发光面 Luminous surface	22mm	色温 Temperature	正白 (6500K) white
功率 power	396W	全套数量 Full set quantity	外框+内框 Outer frame + inner frame
尺寸 size	2435x4835mm		

编号 NO	配件明细 Parts	数量 quantity
A	1175mm灯管/Lamp tube	12
B	565mm灯管/Lamp tube	24
C	直通/Direct connection	8
D	直角/Right angle	3
J		

编号 NO	配件明细 Parts	数量 quantity
E	T型/T-shaped	14
H	电源线/Power cord	13